

MELBOURN PARISH COUNCIL

(District of South Cambridgeshire)

A meeting of this Council was held on Monday, 27 September 2021 at 7.30pm in the Austen Room, Community Hub, 30 High Street, Melbourn, Cambridgeshire SG8 6DZ

Members of the public are reminded that copies of reports and supporting documentation for agenda items can be obtained from the Parish Council website or on request to the Clerk

Present: Cllrs Clark (Chair), Barnes, Cowley, Davey, Hart, Kilmurray, Travis, Wilson

Absent: Cllr Baker

In attendance: Claire Littlewood (Parish Clerk), County Cllr van de Ven, District Cllr Hales

PC068/21 To receive and approve apologies for absence

No apologies for absence were received.

PC069/21 To receive any Declarations of Interest and Dispensations

- a) To receive declarations of interest from councillors on items on the agenda
- b) To receive written requests for dispensations for disclosable pecuniary interests (if any)
- c) To grant any requests for dispensation as appropriate

None received.

PC070/21 To consider an application to be co-opted to the Parish Council

A resident had expressed an interest in standing for co-option. Forms not yet received – to be deferred until the Parish Council meeting on 25 October 2021.

PC071/21 Chairs' Announcements – For information only

Nothing to report.

PC072/21 To approve the minutes of the Parish Council Meeting held on 2 August 2021

A member queried whether cllrs who were not in attendance could then vote to accept the minutes of a meeting. Cllrs were referred to NALC Legal Topic Note 5 (point 71) which states that '***The attendance (or otherwise) of the Chairman or those voting in favour to amend or approve of the minutes is irrelevant.***'. It was noted that it was good practice that those not in attendance should not propose or second approval of the minutes.

A member noted a correction required at PC061/21a), the last sentence should read '*... reimbursement of the additional electrical costs provided **the** Hub*'

It was:

RESOLVED to approve the minutes of the Parish Council meeting held on 2 August 2021 as amended as an accurate record.

Proposed by Cllr Kilmurray, seconded by Cllr Davey. All in favour.

PC073/21 To report back on the minutes of the Parish Council Meeting held on 2 August 2021

PC057/21 Disposal nappies and dog waste bags are disposed of in land fill. Incineration would be at the cost of the Parish Council.

PC062/21c) Awaiting costing from independent contractor. **ACTION:** Clerk to chase

PC074/21 Public Participation: (For up to 15 minutes members of the public may contribute their views and comments and questions to the Parish Council – 3 minutes per item).

Written responses to questions raised will be made by the Parish Office within 14 days of the date of this meeting.

There were no members of the public in attendance.

PC075/21 To receive reports from the District and County Cllrs for Melbourn

Deferred to later in the meeting to accommodate County Cllr van de Ven.

PC076/21 Governance:

- a) To receive and consider the external auditor's report

It was:

RESOLVED to accept the external auditor's report.

Proposed by Cllr Wilson, seconded by Cllr Cowley. All in favour.

- b) To note updated building reinstatement valuations

The report was noted. A member noted that 83 High Street was described as a memorial garden. **ACTION:** Clerk to request Bremner Partnership to amend the description.

- c) To consider quotations for the Parish Council's insurance provision for 2021/22

[Post meeting note: This item heading incorrectly refers to insurance provision for 2022/23 whereas the quotes considered are for 2021/22.]

Insurance renewal premium based on new reinstatement valuations has increased to £18,833.43. Noted that only one quote was available from the broker. Broker had approached a second insurer who declined to cover timber framed buildings. Discussion with regard to seeking alternative quotes. Current insurer has confirmed a 7 day extension of cover.

It was:

RESOLVED that the Clerk should have 5 days within which to seek alternative quotations for insurance cover for 2021/22.

Proposed by Cllr Cowley, seconded by Cllr Hart. All in favour.

Discussion in the event that (a) a more competitive quotation was obtained from an alternative insurance provider or (b) no suitable alternative quotation could be obtained. Noted that additional insurance premium would be paid from reserves.

It was:

RESOLVED to give the Clerk delegated authority to accept a more competitive quote on similar terms subject to approval by Chair of the Council and Chair of Finance and Good Governance OR if no suitable alternative quotations could be obtained, to accept the renewal quotation from AXA in the sum of £18,833.43.

Proposed by Cllr Barnes, seconded by Cllr Kilmurray. All in favour.

ACTION: Clerk to identify insurers willing to cover timber framed buildings and to seek further insurance quotations.

- d) To note email decisions taken since the last full Council meeting

Email decisions relating to transfer of open spaces from Stonebond (Orchard Gardens) and expenditure on new server for the Hub were noted.

- e) To discuss and consider live streaming Parish meetings

Noted that this item had been discussed by Finance and Good Governance Committee and was brought to full Council for consideration. Discussion as to the technical requirements for live streaming meetings over Zoom. Members noted the

importance of making meetings accessible for residents with mobility issues.
 Discussion as to possibility of holding meetings in the Atrium on the ground floor.
 Discussion with regard to importance of meeting etiquette both on and off line. Noted that audio recordings of meetings are currently available via the website.

[20:15 County Cllr van de Ven joined the meeting]

It was:

RESOLVED to ask the Clerk to seek further information on other Councils that are live streaming meetings.

Proposed by Cllr Cowley, seconded by Cllr Hart. In favour: None. Against: Cllrs Clark, Davey, Cowley, Wilson, Travis and Hart. Abstain: Cllrs Kilmurray and Barnes. The resolution fell.

Discussion with regard to holding parish meetings in the Atrium. Noted that the Atrium will require additional set up as the area is currently used for storing tables and chairs from the marquee. Also need to be aware of ensuring hygiene protocols are maintained.

- f) To receive any updates and consider actions

There was nothing further to discuss.

PC075/21 To receive reports from the District and County Cllrs for Melbourn

County Cllr van de Ven was invited to present the report on behalf of County and District Cllrs. The report was received with thanks.

PC077/21 Finance Matters:

- a) To consider the approvals list for August and September 2021

ACTION: Clerk to check invoices for electricity charges for August and September for the Pavilion.

It was:

RESOLVED to approve the approvals list for August 2021.

Proposed by Cllr Cowley, seconded by Cllr Davey. All in favour.

It was:

FURTHER RESOLVED to approve the approvals list for September 2021.

Proposed by Cllr Wilson, seconded by Cllr Kilmurray. All in favour.

- b) To receive and consider the finance reports for July and August 2021.

The finance reports were received.

- c) To receive any updates and consider actions.

There was nothing further to report.

PC078/21 To note the bank reconciliations for July and August 2021

The bank reconciliations were noted.

PC079/21 Community Hub Extension Project

- a) To receive any updates and consider actions

Awaiting any outstanding invoices to make final budget reconciliation. SDC have agreed to complete landscaping around the building – this was noted with thanks.

- a) To consider formal offer to transfer open space at 36 New Road

It was:

RESOLVED to accept transfer of the open space at 36 New Road subject to agreement of the 10 year commuted sum.

Proposed by Cllr Kilmurray, seconded by Cllr Barnes. All in favour.

- b) To consider approving revised Deed of Easement for drainage works on the Old Rec

It was:

RESOLVED to approve the amended Deed of Easement, RAMS and supporting plans for drainage works on the Old Rec.

Proposed by Cllr Kilmurray, seconded by Cllr Wilson. All in favour.

- c) To receive any updates and consider actions

There was nothing further to discuss.

PC081/21 Maintenance Matters:

- a) To consider quotations for fencing at The Cross

Quotes not yet received – deferred for future meeting.

- b) To consider approving a quotation for repainting the metal grill at the pavilion

Quote for external decoration of the pavilion had been approved by Maintenance Committee. The cost of repainting the metal grill exceeded budget by £200 and was recommended by Maintenance Committee (MA083/21a) to full Council for approval).

It was:

RESOLVED to approve the quote from Darren Harward for repainting the metal grill on the Pavilion at a cost of £800.

Proposed by Cllr Travis, seconded by Cllr Hart. All in favour.

- c) To consider approving a quotation for repairs to the heating system at the pavilion

A quote for remedial works to the plumbing system at the pavilion had been received from Shelford Heating. Work was required following legionella assessment and recommended by Maintenance Committee (MA083/21b) to full Council for approval.

It was:

RESOLVED to approve items 1, 3, 4 and 5 in the sum of £574.26 + VAT from the quotation received from Shelford Heating.

Proposed by Cllr Travis, seconded by Cllr Hart. All in favour.

- d) To receive any updates and consider actions.

Thanks was noted to the wardens for their work in successful removing graffiti from the chess table and chairs at the side of the pavilion.

PC082/21 To receive the Timebank Coordinator's report

The Timebank Coordinator's reports were received with thanks.

PC083/21 HR Matters:

- a) To receive a report from the HR Panel

Noted that two new litter pickers were working as independent service providers. Their efforts were noted with thanks and they would be encouraged to charge for full hours worked.

- b) To receive any updates and consider actions

A fuller HR report to be available at the October meeting.

PC084/21 Policies and Terms of Reference:

- a) To consider approving the revised Litterpicking Risk Assessment for Staff and Service Providers

It was:

RESOLVED to approve the revised Litterpicking Risk Assessment for Staff and Service Providers.

Proposed by Cllr Travis, seconded by Cllr Barnes. All in favour.

- b) To consider approving the revised Financial Risk Register

It was:

RESOLVED to approve the revised Financial Risk Register.

Proposed by Cllr Kilmurray, seconded by Cllr Cowley. All in favour.

- c) To consider adopting a Modern Slavery Statement

It was:

RESOLVED to adopt the Modern Slavery Statement.

Proposed by Cllr Davey, seconded by Cllr Barnes. All in favour.

PC085/21 To note the date of the next meeting : 25 October 2021

The next meeting is scheduled for 19:30 on Monday, 25 October 2021.

The meeting closed at 21.02

MELBOURN PARISH COUNCIL

(District of South Cambridgeshire)

**A meeting of this Council was held on Monday, 2 August 2021 at 7.30pm at All Saints
Community Hall, Station Road, Melbourn, SG8 6DY**

Members of the public are reminded that copies of reports and supporting documentation for agenda items can be obtained from the Parish Council website or on request to the Clerk

Present: Cllrs Clark (Chair), Baker, Barnes, Buxton, Cowley, Davey, Kilmurray

Absent:

In attendance: Claire Littlewood (Parish Clerk), two representatives from Stonebond Properties

PC051/21 To receive and approve apologies for absence

Apologies were received from Cllrs Hart, Travis and Wilson. Acceptable reasons were given.

It was:

RESOLVED to accept the apologies for Cllrs Hart, Travis and Wilson.

Proposed by Cllr Kilmurray, seconded by Cllr Buxton. All in favour.

PC052/21 To receive any Declarations of Interest and Dispensations

- a) To receive declarations of interest from councillors on items on the agenda
- b) To receive written requests for dispensations for disclosable pecuniary interests (if any)
- c) To grant any requests for dispensation as appropriate

Cllr Kilmurray declared an interest in item PC061/21a) – d) as a Director of the Hub Management Group. He was given dispensation to participate in the discussion but not to vote.

PC053/21 Chairs' Announcements – For information only

Chair advised that the MVAS boxes had been received and would be installed soon.

Chair advised that a used eBike had been identified and was available for inspection at the meeting.

PC054/21 To approve the minutes of the Parish Council Meeting held on 28 June 2021

It was:

RESOLVED to approve the minutes of the Parish Council Meeting held on 28 June 2021 as an accurate record.

Proposed by Cllr Baker, seconded by Cllr Barnes. All in favour.

PC055/21 To report back on the minutes of the Parish Council Meeting held on 28 June 2021

Clerk reported that actions under items PC041/21b), PC041/21d), PC042/21d), PC045/21a), PC048/21a) were on the agenda for further discussion.

PC056/21 Public Participation: (For up to 15 minutes members of the public may contribute their views and comments and questions to the Parish Council – 3 minutes per item). Written responses to questions raised will be made by the Parish Office within 14 days of the date of this meeting.

Two representatives from Stonebond Properties were in attendance.

The Chair altered the order of the Agenda to bring forward item PC062/21a)

PC062/21 Planning Matters:

- a) To note email decision to respond to Stonebond's offer to transfer the open spaces on the Orchard Gardens development

An email decision to respond to Stonebond's offer to transfer the open spaces was noted.

Chair welcome representatives of Stonebond. Stonebond Planning Manager requested a detailed breakdown of our contractor's estimate of ongoing costs. Indicated that estimated costs appeared excessive and they would seek a further quote for comparison. Discussion with regard to likely maintenance costs and concerns over drainage, particularly of the LAP. Noted that deadline for negotiations is 19 August 2021.

Further discussion with regard to non-adherence to agreed traffic and construction management plan. Noted that the parish office receives regular complaints regarding vehicle parking. Stonebond Site Manager indicated that contractor parking is being monitored. Additional on site parking is being made available. Parking will be monitored.

PC057/21 To receive reports from the District and County Cllrs for Melbourn

The report was received. **ACTIONS:** Clerk to check whether Shared Services waste collection have capacity to incinerate disposable nappies. Also check how dog waste bags are disposed of.

PC058/21 Governance:

- a) To approve signature of an Indemnity relating to Supplementary s106 Agreement for Victoria Heights
It was:
RESOLVED to approved signature of the Indemnity relating to Supplementary s106 Agreement for Victoria Heights.
Proposed by Cllr Cowley, seconded by Cllr Kilmurray. All in favour.
- b) To note updated Internal Auditor's report
The updated reported was noted.
- c) To invite nominations for members of the Finance and Good Governance Committee
It was:
RESOLVED to approve Cllr Baker's nomination to join Finance and Good Governance Committee.
Proposed by Cllr Cowley, seconded by Cllr Davey. All in favour.
- d) To invite nominations for members of the Maintenance Committee
No nominations were received.
- e) To consider an application for Street Trading Licence
Discussion with regard to potential for increased littering in the area.
It was:
RESOLVED to support the application for a Street Trading Licence with a request that the vendor is responsible for clearing the area of litter.
Proposed by Cllr Kilmurray, seconded by Cllr Cowley. All in favour.
- f) To discuss and consider making a LHI grant application
An update was provided following a meeting with Highways Project Manager. Area of concern is New Road approach to the village. Application for LHI grant to be submitted by September 2021. The proposed project will cost in the region of £20,000. Any shortfall in grant awarded could be precepted for next year. Grants go through preliminary stage before being approved for full consideration.
It was:
RESOLVED to make an application for an LHI grant based on Highways report. If initial grant application is accepted, a more detailed application is to be submitted. Any shortfall in the grant awarded to be precepted.
Proposed by Cllr Barnes, seconded by Cllr Davey. All in favour.
- g) To consider approving wording for memorial bench in Stockbridge Meadows
It was:
RESOLVED to approve the wording for the memorial bench in Stockbridge Meadows.
Proposed by Cllr Cowley, seconded by Cllr Barnes. All in favour.
- h) To receive any updates and consider actions
There was nothing further to discuss.

PC059/21 Finance Matters:

- a) To consider retrospective approval for the approvals list for July 2021
It was:
RESOLVED to retrospectively approve the approvals list for July 2021.
Proposed by Cllr Cowley, seconded by Cllr Kilmurray. All in favour.
- b) To receive and consider finance report for June 2021
The finance report was received.
- c) To consider approving revised IT support costs
Discussion with regard to increased IT support costs for backup. Noted that costs are high but includes restoration in the event of a loss of data. Further research to be carried out and reviewed. Noted that it would be preferable to keep all IT support with one provider.

It was:
RESOLVED to approve the increase in IT support costs but to carry out a review the IT support package and seek comparative costs for consideration.
Proposed by Cllr Baker, seconded by Cllr Buxton. All in favour.
- d) To consider approving expenditure from reserves for an electric bike
eBike and trailer is to be made available for use by new litterpicker. A pre-owned eBike was available at the meeting for inspection (2-3 years old, only c.30 miles, excellent condition). Cllr Davey noted an interest as the eBike belongs to a family member.
It was
RESOLVED to purchase the pre-owned eBike at a cost of £400.
Proposed by Cllr Kilmurray, seconded by Cllr Buxton. In favour: Cllrs Kilmurray, Buxton, Baker, Barnes, Cowley, Clark. Abstain: Cllr Davey
- e) To receive any updates and consider actions
There was nothing further to discuss.

PC060/21 To note the bank reconciliations for June 2021

Item deferred until September meeting.

PC061/21 Community Hub Extension Project

- a) To receive an update on the Hub Extension Project

The report was received. Discussion with regard to additional electrical works over and above that already approved by Council (£3,931.48 - PC106/20a : meeting 22 February 2021 and £3,500 - Item 4 : meeting 10 May 2021). Noted that the Hub Management had agreed the fund additional electrical works likely to be in the region of £13,000 to avoid delaying the project. Full Council approval will be required for reimbursement of the additional electrical costs provided the Hub extension budget is not overspent.
- b) To consider retrospectively approving additional Structural Engineers fees
It was:
RESOLVED to retrospectively approve the additional Structural Engineers fees of £200.
Proposed by Cllr Davey, seconded by Cllr Barnes. In favour: Cllrs Davey, Barnes, Barker, Buxton, Clark, Cowley. Abstain: Cllr Kilmurray.
- c) To consider retrospectively approving additional scaffolding hire costs
It was:
RESOLVED to retrospectively approve additional scaffolding hire costs of £100.
Proposed by Cllr Baker, seconded by Cllr Davey. In favour: Cllrs Baker, Davey, Barnes, Buxton, Clark, Cowley. Abstain: Cllr Kilmurray.
- d) To receive any updates and consider actions
There was nothing further to discuss.

PC062/21 Planning Matters:

- b)** To consider purchase of open space on Greengage Rise from Taylor Wimpey
Noted that Taylor Wimpey's legal fees are capped at £550. Parish Council legal fees estimated to be in the region of £1,200-£1,400.
It was:
RESOLVED to approve purchase of the open space on Greengage Rise from Taylor Wimpey at the cost of £1 plus legal fees
Proposed by Cllr Kilmurray, seconded by Cllr Barnes. All in favour.
- c)** To receive an update on Hopkins Homes offer to transfer the SGB
Report from independent landscape architect highlights concerns with regard to SGB. Further questions to be raised with developer (cc s106 Officer and Landscape Officer). **ACTION:** Clerk to obtain quote for obtaining detailed horticulturalist report.
- d)** To receive an update on Dolphin Lane verge
Update received regarding a request to extend property boundary on Dolphin Lane. Resident has been advised that boundary must not be extended and verge to be returned to original condition.
- e)** To receive any updates and consider actions
There was nothing further to report.

PC063/21 Maintenance Matters:

- a)** To discuss and consider a suggestion relating to Ground Source Heat Pump heat network
Discussion with regard to GSHP network in Swaffham Prior. Noted that any similar project would be a much larger scale.
ACTIONS:
- Clerk to forward to County Cllr van de Ven to see if this is something that could be taken further.
- Clerk to respond and thank resident for their interest and provide an update on the discussion.
- b)** To receive an update on Pavilion heating costs
To be monitored. Discussion with regard to upgrading bulbs on footpath lights and Pavilion veranda to LED. **ACTION:** Clerk to follow up with wardens to change lightbulbs to LEDs.
- c)** To receive any updates and consider actions.
There was nothing further to report.

PC064/21 To receive the Timebank Coordinator's report

The report was received.

PC065/21 HR Matters:

- a)** To receive an update from the HR Panel
Nothing to report from the HR Panel.
- b)** To consider approving CILCA training course for Assistant to the Clerk
It was:
RESOLVED to approve Assistant to the Clerk registering for CiLCA training course at a cost of £400 + VAT.
Proposed by Cllr Kilmurray, seconded by Cllr Buxton. All in favour.
- c)** To consider approving Clerk's attendance at SLCC National Conference
It was:
RESOLVED to approve Clerk's attendance at the SLCC National Conference at a cost of £140 + VAT.
Proposed by Cllr Cowley, seconded by Cllr Baker. All in favour.
- d)** To consider approving amended Independent Service Provider Agreement

It was:

RESOLVED to approve the Independent Service Provider Agreement as amended.
Proposed by Cllr Cowley, seconded by Cllr Barnes. All in favour.

- e) To receive any updates and consider actions

There was nothing further to report.

PC066/21 Policies and Terms of Reference:

- a) To consider adopting Terms of Reference for the Website Working Party

It was:

RESOLVED to adopt the Terms of Reference for the Website Working Party.
Proposed by Cllr Cowley, seconded by Cllr Barnes. All in favour.

PC067/21 To note the date of the next meeting :

The date of the next meeting was noted as Monday, 27 September 2021

The meeting closed at 21:23

Melbourn Parish Council September 2021

Local Plan 'First Proposals' – including Melbourn, Thakeham and the bigger picture

The long process of putting together a Local Plan – the statutory framework for population growth and house building – included a 'Call for Sites' period which saw over 690 sites submitted for consideration. These were then assessed over a two-year period, during which 'late' submissions were legally required to be accepted. The final closing date for late submissions was August 31, because on Sept 1 South Cambs as the Local Planning Authority announced its 'First Proposals' based on the assessment of all sites submitted in the Call for Sites window.

All local authorities must align their Local Plans with central government parameters. Greater Cambridge as a nationally important economic growth area must in its Local Plan support the whole population with particular regard for lower paid key workers who require affordable homes, and with the necessary infrastructure for development that is 'sustainable' including things like travel to work. Climate change and water resource are the headline considerations in these First Proposals. The Local Plan in essence provides protection for sustainable development.

After SCDC committees have scrutinised and commented on the proposals, the council will make any changes that are agreed. SCDC will then publish the First Proposals for full public consultation during November and December 2021.

Out of the long assessment process, 19 of the 690+ sites were taken forward to the next stage, with the bulk of proposals centred primarily around established growth sites like Cambourne, where the gradual process of infrastructure development has been taking place over a period of decades. Two sites are proposed in Melbourn, off The Moor and Cambridge Rd.

A very readable and useful website is here

<https://www.greatercambridgeplanning.org/emerging-plans-and-guidance/greater-cambridge-local-plan/>

And attached to this report please find a Powerpoint presentation published by the South West Cambridge Action Group that provides more context for Melbourn, Thakeham's vision and the current stage of the Local Plan.

Civil Parking Enforcement being explored for South Cambs

The County Council is supporting the principle of civil parking enforcement for South Cambs – in which the Council would oversee inconsiderate parking including for example pavement parking. The process involves the Council applying to the Secretary of State for a Special Enforcement Area. The Greater Cambridge Partnership has agreed to fund the project if it is decided to go ahead.

Communities Duty Team, South Cambs

The Team set up during Covid's first lockdown continues to communicate every two weeks with parish councils and community groups. Funding runs until next spring. There remain useful links for people in our community who need support including from Food Banks, social contact and community health services. We are exploring longer term opportunities for supporting people, which these practical networks have provided thus far.

Electoral Register – letter to all households

South Cambs District Council has written to all households to update the electoral register, taking account of all eligible voters in a household. Many responses are awaited.

<https://www.householdresponse.com/Home/Welcome>

Riparian Ownership and responsibilities for ditches and watercourses

Both the district and county councils are actively working to improve information dissemination on riparian ownership.

Cambs County Council reports: "As part of our Community Flood Action Programme, we are updating our riparian guidance document to make it more useful for those living next to a watercourse. As this document is aimed at residents and landowners, we wish to seek their views and get a better understanding of their awareness of riparian issues. We have therefore prepared a short survey (5 questions) which has been reviewed and approved by our Surveying Analyst Team. We would be grateful if you could disseminate this with your residents and parishes by social media, word of mouth or on your website/publications." Deadline is Sept 30 but could be extended. A link to the survey is here: <https://forms.office.com/r/5HQbNqGtba>

Citizens Advice at the Melbourn Hub

It's great to see Citizens Advice back at Melbourn Hub every Wednesday from 10am to midday. Thanks to all at the Hub for the amazing work on the extension. The North Herts Citizens Advice AGM is next month; we've written to thank them for their support in Melbourn.

Home adaptations for living independently

Every year the district and county councils complete an annual report showing how many home adaptations for disabled and older people have been completed. You can see it at here: <https://www.cambshia.org/about-us/plans-and-performance/>.

Given the challenges in 2020/21, it's great that although the number of adaptations completed and the spend was lower than in previous years, we still managed to complete 166 adaptations investing over £2m to enabling residents to live more independently in their own home. Our service works closely with Occupational Therapists who were heavily redeployed to primary care services because of the pandemic – we look forward to a busy year ahead as these critical services resume. If you or a relative needs help to continue living at home please contact hia@cambshia.org.

Vaccine boosters

The Government has announced that some people will be eligible for booster vaccinations. If you are over 50 or clinically extremely vulnerable, then you will be invited to get your booster vaccination by your GP or through the national booking service. If you are eligible because of your role as a health and social care worker then you will receive a letter shortly from your local authority setting out how to book for your vaccine.

NHS restructure & collaboration with County and District Councils

You may have read about the replacement of NHS 'Clinical Commissioning Groups' by the new 'Integrated Care System (ICS)' structure that comes into force next April. This is occupying

considerable time and effort, as the County Council's statutory social care role means much joint working with the NHS. For those interested in the nuts and bolts:

As part of the national ICS development programme, Clinical Commissioning Groups (CCGs) will no longer exist from April 2022. CCGs will become Integrated Care Systems (ICSs) with a slim executive team – Chief Executive, Finance Director, Director of Nursing, Medical Director; with support from a small team. There is currently one Clinical Commissioning Group (CCG) across Cambridgeshire and Peterborough, whereas other Authorities have more than one CCG. We will have a Cambridgeshire and Peterborough ICS.

CCG Budgets, including direct delivery and commissioning, will mostly be devolved to Acute Hospitals, health community services – Cambridgeshire & Peterborough Foundation Trust, (CPFT) Cambridgeshire Community Services (CCS) - and GPs.

Recently GPs have joined up into Primary Care Networks (in Cambridgeshire and Peterborough there are 21 PCNs. Orchard Surgery Melbourn is part of the Meridien PCN, as are Bourn, Comberton Harston and the two Royston surgeries (yes, one of the geographic anomalies of the Cambs/Peterborough footprint).

Sitting under the overall ICS, there will be two 'Integrated Care Partnerships' (ICP)

- North: Peterborough, Fenland and Huntingdonshire
- South: East, Cambridge City and South Cambridgeshire

And several countywide 'Collaboratives':

- Children and Maternity
- Mental Health/Learning Disability
- Acute
- Clinical

Each of the ICPs will work together with the PCNs, local health organisations and social care providers, collaboratives and the Voluntary and Community Sector within their area to deliver the services needed locally. The County Council will be actively involved as the Local Authority with statutory responsibility for social care.

An NHS Integrated Commissioning Board will be accountable for the delivery of health and care outcomes and health budgets. This will comprise the ICS Executive, the ICPs and Collaboratives, with representation from Local Authorities (membership maybe extended).

There will also be an Integrated Care Partnership Board; we are looking at the synergies between this and the Health & Wellbeing Board (chaired by the County Council and with the District Councils involved too) and considering joining these up to create one plan and a set of agreed priorities.

Recruitment of the Chief Executive of the ICS is now taking place, with others being recruited to by January 2022.

County Council's New Shire Hall, Alconbury

Construction of the 'New Shire Hall' building HQ for Cambs County Council, a project of the previous administration, has now opened in a phased return to work plan and September committee meetings have taken place there. Based at Alconbury Weald off the A1 toward Peterborough, there

are no viable public transport connections from most parts of the county. It remains to be seen whether the impressive cycle parking facilities there will be put to use.

The most surprising feature of New Shire Hall is that it contains no space large enough to hold a meeting of Full Council. Therefore, the County Council will be forced to hire a suitable venue for each of its Council meetings. The next meeting on November 9 takes place at Burgess Hall, St Ives.

New Shire Hall stands directly adjacent to the 'iMET' vocational training centre, a £10 million project launched in 2018, which has now collapsed and is closed, due to lack of public transport access.

Combined Authority News – transport and climate action

The new Mayor Nik Johnson is moving forward with bus franchising proposals. Currently 90% of bus services are commercial and councils therefore have no control over their routes, frequencies or fares. We know that we urgently need at least a 24% shift to public transport from cars to reduce carbon emissions significantly and this won't happen unless we have attractive public transport alternatives.

The draft business case is expected in the Autumn prior to plans going out to public consultation. The leaders of the district and county councils appealed for subsidised travel for young people as we are well aware that in rural villages getting young people to education or training is a real problem if you don't have access to a car.

The Mayor declined to declare a Climate Emergency but has established a Lead Member role for Climate Change and Environment which he has offered to the leader of South Cambs, Bridget Smith. The Combined Authority Board voted, not unanimously, to accept all of the recommendations of the recently completed Independent Climate Change Commission which focused on moving us swiftly to Zero Carbon. It is disappointing that not all members of the board accepted that rewetting peat is absolutely critical to minimising carbon emissions in our region and that future drying out of peat will in fact cause vast quantities of carbon to be released into the atmosphere.

The Combined Authority has been awarded £172k to run a career hub for next year. It will involve 30 schools and colleges and will hopefully help to get our young people into training and jobs.

Welcoming Afghan Refugees

Thanks to local residents who have been in touch asking how they can support Afghan refugee families. The District and County Councils are working together to offer homes to 3 families escaping the terror in Afghanistan, using houses available through SCDC's private rental housing company. The County Council with specialist charities will make sure that these people have the access they need to support, education and health services so that they can start to rebuild their lives.

Greater Cambridge Planning Local Plan and South West Cambridgeshire New Town Update

September 2021

Greater Cambridge Planning: Breakdown of existing and new sites

Location	Current pipeline (adopted allocations, existing permissions and windfall allowance)	Proposed increased delivery rates/densification on existing allocated sites	New proposed allocations	Total
City (urban area)	5,791 (16%)		3,912 (43%)	9,703 (20%)
Edge of Cambridge	8,003 (22%)	1,000 (40%)	2,850 (31%)	11,853 (24%)
New settlements	15,225 (41%)	1,500 (60%)	1,950 (21%)	18,675 (38%)
Rural area	8,179 (22%)		384 (4%)	8,563 (18%)
Total	37,198 (100%)	2,500 (100%)	9,096 (100%)	48,794 (100%)
Proportion of housing supply	76% of total delivery	5% of total delivery	19% of total delivery	

Local Plan Summary

- Local Plan set the bar high:
 - Minimal carbon impact (minimal commuting from villages to City).
 - Developments not permitted where water resources could be under pressure.
- 600+ sites submitted
 - 19 new sites chosen
 - Local plan identified 7,200 new homes required.
 - Extra homes with a buffer 4,440
- Total 11,640 between 2021-2041
- **Extra rural homes 384**

South West Cambridgeshire Action Group (SWCAG)

Thakeham

- Submitted nothing to Call for Sites
- Published its plan for 25,000 homes the day after publication.
- No account taken of carbon.
- No account taken of water resources.
- No account taken of the 11,000 homes identified as sufficient let alone the 384 in the rural area.
- Have been flying surveillance helicopters over local villages.

Next Options for them:

- Submit a planning application to South Cambs.
- Secure Central Government support (presumably as part of Government OxCam Arc).

Number of new homes Gt Cambridge

Already in the plan
from previous 2018
Local Plan

Additional
requirement with
buffer



**Existing homes in Greater Cambridge:
124,389**



**New homes already in the pipeline
for 2020-2041: 37,200**

These will be built on sites allocated in current Local Plans, sites which already have planning permission, and on 'windfall' sites which are not specifically identified in plans but which are policy compliant.



**Additional homes required to meet our
housing need for 2020-2041: 7,200**

Our total identified need for the period is 44,400 homes.



**Extra homes we aim to plan for, to
give us approximately a 10% buffer
for flexibility: 4,440**

South West Cambridgeshire Action Group (SWCAG)

Greater Cambridge Planning : Location and number of new homes & Thakeham

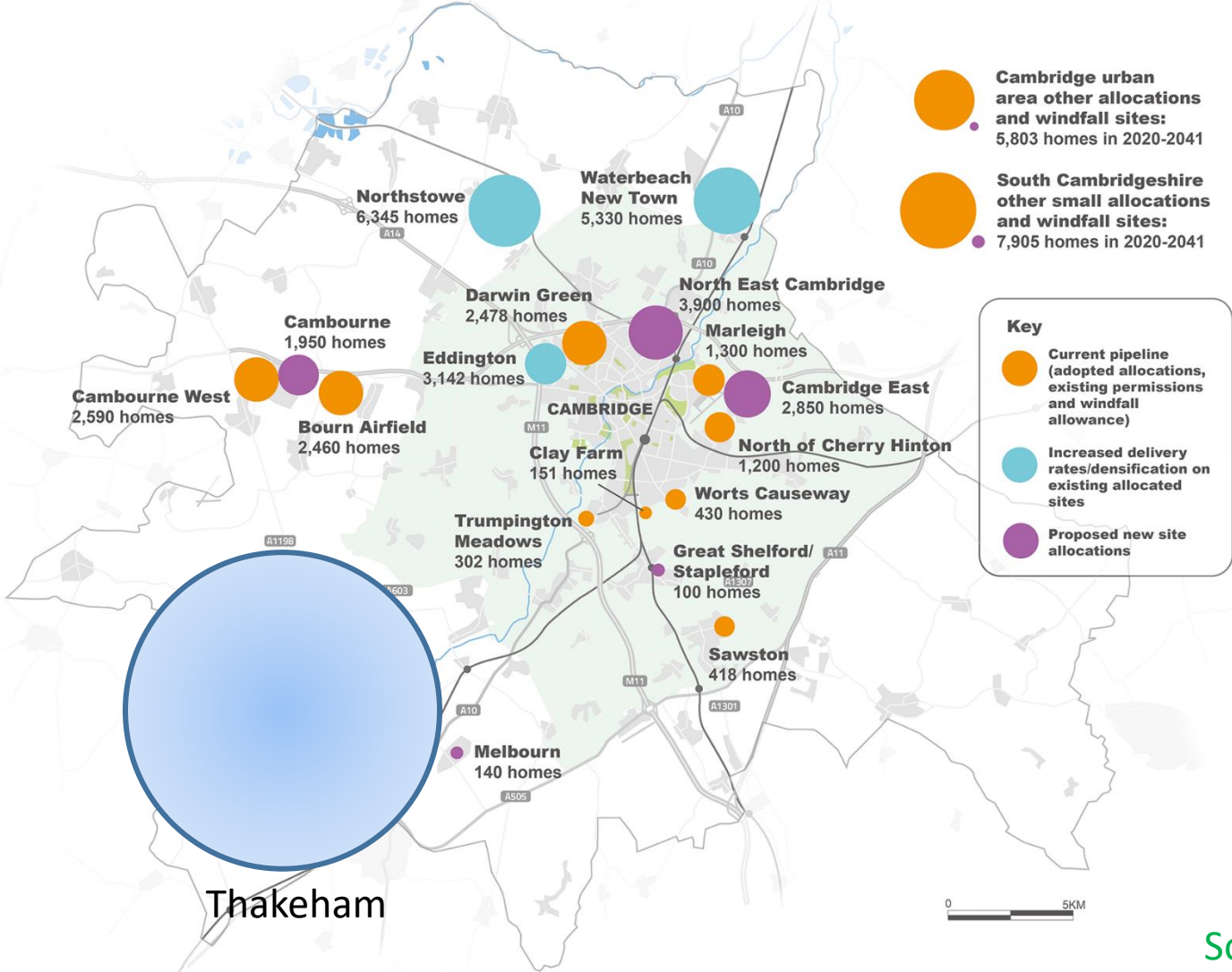

Location	Increased delivery rates/ densification on existing allocated sites	New proposed allocations
City (urban area)		3,912 (43%)
Edge of Cambridge	1,000 (40%)	2,850 (31%)
New settlements	1,500 (60%)	1,950 (21%)
Rural area		384 (4%)
Total	2,500 (100%)	9,096 (100%)

SWCAG Next Steps

National:

1. Make new Freedom of Information requests to Homes England & the Ministry of Housing, Communities and Local Government on discussions between government and Thakeham about its proposed new town (previous requests have been rejected as 'not in the public interest.')
2. Request Anthony Browne MP to ask the Housing Minister to comment specifically on the status of Thakeham's plans.
3. Ask Thakeham to now withdraw their proposal as it is at complete odds with the principles of sustainable development in South Cambridgeshire.

Local:

1. Ask Thakeham if they intend to submit a planning application to the South Cambs District Council.
 - If so, lobby SCDC Planning Committee for outright refusal.
 - If not, ask SCDC to move forward and ratify its Local Plan without Thakeham.
2. Respond to the government's OxCam Arc consultation with the benefit of sustainable development principles now set out in the Local Plan's First Proposals.

Section 3 – External Auditor Report and Certificate 2020/21

In respect of MELBOURN PARISH COUNCIL - CA0179

1 Respective responsibilities of the body and the auditor

This authority is responsible for ensuring that its financial management is adequate and effective and that it has a sound system of internal control. The authority prepares an Annual Governance and Accountability Return in accordance with *Proper Practices* which:

- summarises the accounting records for the year ended 31 March 2021; and
- confirms and provides assurance on those matters that are relevant to our duties and responsibilities as external auditors.

Our responsibility is to review Sections 1 and 2 of the Annual Governance and Accountability Return in accordance with guidance issued by the National Audit Office (NAO) on behalf of the Comptroller and Auditor General (see note below). Our work **does not** constitute an audit carried out in accordance with International Standards on Auditing (UK & Ireland) and **does not** provide the same level of assurance that such an audit would do.

2 External auditor report 2020/21

On the basis of our review of Sections 1 and 2 of the Annual Governance and Accountability Return (AGAR), in our opinion the information in Sections 1 and 2 of the AGAR is in accordance with Proper Practices and no other matters have come to our attention giving cause for concern that relevant legislation and regulatory requirements have not been met.

Other matters not affecting our opinion which we draw to the attention of the authority:

None.

3 External auditor certificate 2020/21

We certify that we have completed our review of Sections 1 and 2 of the Annual Governance and Accountability Return, and discharged our responsibilities under the Local Audit and Accountability Act 2014, for the year ended 31 March 2021.

External Auditor Name

PKF LITTLEJOHN LLP

External Auditor Signature

Date

31/08/2021

* Note: the NAO issued guidance applicable to external auditors' work on limited assurance reviews in Auditor Guidance Note AGN/02. The AGN is available from the NAO website (www.nao.org.uk)

MELBOURN PARISH COUNCIL
Full Council : 27 September 2021

Item: PC076 21d) Emails decisions

Transfer of open space from Stonebond Properties : 29 July 2021

Dear all

Thank you for responding so promptly to this email decision. There is a clear majority in favour of the proposal as follows:

That council has considered and accepts the 10 year commuted sum of £35,000 offered by Stonebond Properties for maintenance of the open spaces shown on the attached plan on the Orchard Gardens development.

In favour: Cllrs Kilmurray, Barnes, Travis, Hart, Cowley, Clark

Many thanks
Claire

Claire Littlewood
Parish Clerk

Dear all

At the Parish Council meeting on 26 June, there was discussion with regard to transfer of the open spaces on the Orchard Gardens development on The Moor. Councillors indicated that they are in favour of taking on responsibility for maintenance of the open spaces. Stonebond, the developer, has offered £2,005 as an annual sum to be paid for 10 years. On inspection of the site, a number of concerns were raised and we asked our grounds maintenance contractor to provide an independent quote for ongoing maintenance. He has now done this in the sum of £4,500 per annum.

Please see attached:

- Our letter to Stonebond with concerns raised at the full Council meeting on 28 June 2021;
- Note setting out current position;
- DRAFT letter to Stonebond with our counter offer.

At the meeting in June, it was agreed that Cllrs Kilmurray, Travis and Clark should consider this matter and make a recommendation to Council on how to proceed:

PC045/21 Planning Matters:

- a) To consider Stonebond's offer to transfer the open spaces on the Orchard Gardens development
Recent site inspection was noted. Local grounds maintenance contractor has submitted a quote for ongoing maintenance of LAP and LEAP. Concern was noted with regard to drainage of the LAP. Also noted that 50% of maintenance costs submitted by developers contractor relating to insurance and equipment replacement. A member noted that replacement of play equipment on LEAP should be considered in 10 year commuted sum.

ACTIONS:

- Clerk to contact our grounds maintenance contractor to revisit quote.

- Clerk to seek further comparative quotes. Cllr Wilson to provide contact details of contractors.
- Clerk to write to Stonebond to advise that their offer of £2,005 per annum is insufficient and to advise that we are seeking comparative quotes.

Subject to above, Cllrs Kilmurray, Clark and Travis to reconsider and make recommendation to full Council for consideration and email decision.

You will see from the attached note that we are fast approaching the deadline for our response. Cllrs Kilmurray, Travis and Clark have indicated that they are happy to recommend the proposal below to full Council for email approval.

In the circumstances, can I please ask councillors to consider the attached and to vote on the proposal below:

PROPOSAL: To consider approving a counter offer to be made to Stonebond for 10 year commuted sum to be paid for ongoing maintenance of the open spaces on the Orchard Gardens development.

Retrospective approval for expenditure on new server for the Hub : 5 August 2021

Dear all

Thank you for responding to this email proposal. There is a clear majority – therefore:

It is

RESOLVED to give retrospective approval for expenditure of £2,472.00 from precept for the new server.

In favour: Cllrs Clark, Baker, Cowley, Hart, Davey, Wilson

Abstain: Cllr Kilmurray (as a Hub director)

Many thanks

Claire

Claire Littlewood

Parish Clerk

From: Parish Clerk

Sent: 02 August 2021 12:46

To: councillors@melbournparishcouncil.co.uk

Cc: RFO <RFO@melbournpc.co.uk>

Subject: DECISION REQUIRED : New server

Dear all

Retrospective approval for purchase of the new server is required please.

An allowance of £2,500 was made in the precept for replacing the server. Please see the attached invoice from Saker – the following items relate to the replacement server :

- | | |
|--------------|-----------|
| - P16928-421 | £1,680.00 |
| - P11077-A21 | £147.40 |
| - G/S | £645.00 |

These items equal £2,472.00. The balance of the invoice will be recharged to the Hub.

Unfortunately, this invoice was received too late for inclusion on the Agenda for tonight's meeting.

In the circumstances, can I please ask councillors to vote on a retrospective proposal to approve expenditure of £2,472.00 from precept for the new server:

Many thanks

Claire

Claire Littlewood

Parish Clerk

Melbourn Parish Council

August 2021 Expenditure transactions - approval list

Start of year 01/04/21

Tn no	Cheque	Gross	Vat	Net Invoice	Details	Cheque
4570	BACS2108 26AJGRAB	£144.00	£24.00	£120.00	27/07/21 AJ Grab Hire - Muck away (4 wheeler) - Hub Extension	£144.00
		£144.00	£24.00	£120.00	AJ Grab Hire - Total	
4608	BACS2108 26BARLEY	£91.37	£15.23	£76.14	12/08/21 Barley Property Maintenance - Repairs to front Pavillion guttering	£91.37
		£91.37	£15.23	£76.14	Barley Property Maintenance - Total	
4560	BACS2108 26BRIAR	£118.20	£19.70	£98.50	23/07/21 Briar Security Systems - Intruder Alarm annual Maintenance and new battery	£118.20
		£118.20	£19.70	£98.50	Briar Security Systems - Total	
4583	DD210825 BGASORG	£54.30	£2.58	£51.72	06/08/21 British Gas - Electricity bill - old rec ground 02/05/21 - 01/08/21 - actual	£54.30
		£54.30	£2.58	£51.72	British Gas - Total	
4621	BACS2108 26BROWN ST	£2,400.00	£400.00	£2,000.00	27/07/21 Brownstone Building Services Ltd - Final invoice - contracted building works	£2,400.00
		£2,400.00	£400.00	£2,000.00	Brownstone Building Services Ltd - Total	
4500	DD210805 DVLA	£24.06	£0.00	£24.06	05/08/21 DVLA - Parish Van road tax - instalment 5 of 12	£24.06
		£24.06	£0.00	£24.06	DVLA - Total	
4574	DD210812 EON	£12.38	£0.59	£11.79	28/07/21 e.0n - Electricity - Orchard Road Cemetery 28/06/21- 28/07/21 Actual	£12.38
		£12.38	£0.59	£11.79	e.0n - Total	
4600	BACS2108 26GR8	£226.20	£37.70	£188.50	31/07/21 GR8 Tool Hire Ltd - dehumidifier + collection (emergency leak)	
4601	BACS2108 26GR8	£284.40	£47.40	£237.00	31/07/21 GR8 Tool Hire Ltd - heras fencing	
4602	BACS2108 26GR8	£200.64	£33.44	£167.20	31/07/21 GR8 Tool Hire Ltd - portaloos	
4619	BACS2108 26GR8	£40.80	£6.80	£34.00	16/08/21 GR8 Tool Hire Ltd - heras fencing hire and collection	
4620	BACS2108 26GR8	£63.36	£10.56	£52.80	16/08/21 GR8 Tool Hire Ltd - portaloos hire & collection	£815.40
		£815.40	£135.90	£679.50	GR8 Tool Hire Ltd - Total	

Signature

Signature

Date

Melbourn Parish Council

August 2021 Expenditure transactions - approval list

Start of year 01/04/21

Tn no	Cheque	Gross	Vat	Net Invoice	Details	Cheque
4566	DD210816 HAVEN	£2.50	£0.12	£2.38	02/08/21 Haven Power - Street lighting - unmetered supply	
4567	DD210816 HAVEN	£7.18	£0.34	£6.84	02/08/21 Haven Power - Street lighting - unmetered supply	
4568	DD210816 HAVEN	£126.55	£6.03	£120.52	02/08/21 Haven Power - Street lighting - unmetered supply	£136.23
		£136.23	£6.49	£129.74	Haven Power - Total	
4561	BACS2108 26H&CGM	£487.00	£81.17	£405.83	29/07/21 Herts & Cambs Ground Maintenance Limited - Cemeteries ground maintenance - 1/12	
4562	BACS2108 26H&CGM	£906.00	£151.00	£755.00	29/07/21 Herts & Cambs Ground Maintenance Limited - Ground maintenance - recreation grounds	
4563	BACS2108 26H&CGM	£747.00	£124.50	£622.50	29/07/21 Herts & Cambs Ground Maintenance Limited - Verge cutting - June (1/12)	
4564	BACS2108 26H&CGM	£552.00	£92.00	£460.00	29/07/21 Herts & Cambs Ground Maintenance Limited - Grounds maintenance - Jul 1/12	£2,692.00
		£2,692.00	£448.67	£2,243.33	Herts & Cambs Ground Maintenance Limited - Total	
4549	BACS2121 0826LUCID	£31.51	£5.25	£26.26	26/07/21 LUCID Systems - Protected online backup service (uplift 26th-31st July and August 2021)	£31.51
		£31.51	£5.25	£26.26	LUCID Systems - Total	
4630	BACS2108 26HUB	£34.61	£5.77	£28.84	31/07/21 Melbourn Community Hub Management Group - Mobile Phone for Time Bank (13 Jun -12 July)	
4631	BACS2108 26HUB	£34.61	£5.77	£28.84	25/08/21 Melbourn Community Hub Management Group - Mobile Phone for Time Bank (13 Jul -12 Aug)	£69.22
		£69.22	£11.54	£57.68	Melbourn Community Hub Management Group - Total	
4571	BACS2108 26MICKG	£234.00	£39.00	£195.00	30/07/21 Mick George - 8 yard skip	£234.00
		£234.00	£39.00	£195.00	Mick George - Total	

Signature

Signature

Date

25/08/21 04:32 PM Vs: 8.61.00

Page 2

Melbourn Parish Council

August 2021 Expenditure transactions - approval list

Start of year 01/04/21

Tn no	Cheque	Gross	Vat	Net Invoice	Details	Cheque
4550	BACS2108 26NORBUR YS	£7.14	£1.19	£5.95 22/07/21	Norburys Building & Landscape Supplies Ltd - 2nd fix - material hub extension	
4551	BACS2108 26NORBUR YS	£85.92	£14.32	£71.60 23/07/21	Norburys Building & Landscape Supplies Ltd - landscaping - material hub extension	
4552	BACS2108 26NORBUR YS	£480.60	£80.10	£400.50 22/07/21	Norburys Building & Landscape Supplies Ltd - landscaping - material hub extension	
4553	BACS2108 26NORBUR YS	£7.08	£1.18	£5.90 20/07/21	Norburys Building & Landscape Supplies Ltd - 2nd fix - material hub extension	
4572	BACS2108 26NORBUR YS	£20.58	£3.43	£17.15 16/07/21	Norburys Building & Landscape Supplies Ltd - Second fix	
4576	BACS2108 26NORBUR YS	-£32.30	-£5.38	-£26.92 19/07/21	Norburys Building & Landscape Supplies Ltd - Returned Goods	
4594	BACS2108 26NORBUR YS	£108.00	£18.00	£90.00 26/07/21	Norburys Building & Landscape Supplies Ltd - Landscaping	
4595	BACS2108 26NORBUR YS	£27.00	£4.50	£22.50 05/08/21	Norburys Building & Landscape Supplies Ltd - Landscaping	
4596	BACS2108 26NORBUR YS	-£64.80	-£10.80	-£54.00 06/08/21	Norburys Building & Landscape Supplies Ltd - Credit note	
4597	BACS2108 26NORBUR YS	£14.28	£2.38	£11.90 04/08/21	Norburys Building & Landscape Supplies Ltd - second fix	
4598	BACS2108 26NORBUR YS	£43.20	£7.20	£36.00 28/07/21	Norburys Building & Landscape Supplies Ltd - landscaping	£696.70
		£696.70	£116.12	£580.58	Norburys Building & Landscape Supplies Ltd - Total	
4548	DD210801 NOW	£43.20	£7.20	£36.00 27/07/21	Now Pensions - Employer Service Charge August 2021	£43.20
4610	BACS2108 26RICOH	£321.67	£53.61	£268.06 05/08/21	Ricoh UK Limited - Printing 01/05/21-31/07/21 and copier rent 01/08/21-31/10/21	£321.67
		£321.67	£53.61	£268.06	Ricoh UK Limited - Total	

Signature
Date

Signature

Melbourn Parish Council

August 2021 Expenditure transactions - approval list

Start of year 01/04/21

Tn no	Cheque	Gross	Vat	Net Invoice	Details	Cheque
4544	DD210808 WBWS	£5.50	£0.00	£5.50	20/05/21 Source for Business (Cambridge Water) - Work Shop in Car Park -	£5.50
		£5.50	£0.00	£5.50	Source for Business (Cambridge Water) - Total	
4622	DD210801 SCDCCP	£1,198.00	£0.00	£1,198.00	01/08/21 South Cambs District Council - Rates - Car park instalment 5 of 10	£1,198.00
4626	DD210801 SCDCNR	£75.00	£0.00	£75.00	01/08/21 South Cambs District Council - Rates - Victoria Way Cemetery Instalment 5 of 10	£75.00
4416	DD210801 SCDCPAV	£38.71	£0.00	£38.71	01/07/21 South Cambs District Council - Pavillion - Fortnightly waste collection installment 2 of 9	
4624	DD210801 SCDCPAV	£259.00	£0.00	£259.00	01/08/21 South Cambs District Council - Rates - Pavilion Rec Ground Instalment 5 of 10	£297.71
		£1,570.51	£0.00	£1,570.51	South Cambs District Council - Total	
4584	BACS2108 26UP	£619.90	£103.32	£516.58	08/07/21 Urban Plastics - Plumbing parts/pump - Hub extension	
4585	BACS2108 26UP	£34.37	£5.73	£28.64	08/07/21 Urban Plastics - Plumbing parts - Hub extension	
4586	BACS2108 26UP	£92.00	£15.33	£76.67	09/07/21 Urban Plastics - Plumbing parts -taps, pipes, jigsaw blades Hub extension	
4587	BACS2108 26UP	£186.77	£31.13	£155.64	15/07/21 Urban Plastics - Plumbing parts - Hub extension	
4588	BACS2108 26UP	£18.67	£3.11	£15.56	15/07/21 Urban Plastics - Plumbing parts - Hub extension	
4589	BACS2108 26UP	£2.78	£0.46	£2.32	16/07/21 Urban Plastics - Plumbing parts - Hub extension	
4590	BACS2108 26UP	£31.62	£5.27	£26.35	16/07/21 Urban Plastics - Plumbing parts - Hub extension	
4591	BACS2108 26UP	£33.62	£5.60	£28.02	17/07/21 Urban Plastics - Plumbing parts - Hub extension	
4592	BACS2108 26UP	£44.71	£7.45	£37.26	22/07/21 Urban Plastics - Plumbing parts - Hub extension	
4593	BACS2108 26UP	£38.82	£6.47	£32.35	30/07/21 Urban Plastics - Plumbing parts - Hub extension	£1,103.26
		£1,103.26	£183.87	£919.39	Urban Plastics - Total	
		£5,574.69	£0.00	£5,574.69	Confidential items e.g. salaries	

Signature

Signature

Date

Melbourn Parish Council

August 2021 Expenditure transactions - approval list

Start of year 01/04/21

Tn no	Cheque	Gross	Vat	Net Invoice	Details	Cheque
Items Already Paid (Clerk and RFO delegated authority)						
4557	BACS2108 17AIRWAY	£10,866.00	£1,811.00	£9,055.00	22/07/21 Airway - Supply and install 4 Daikin WM A/C units - Melbourn Hub extension	£10,866.00
		£10,866.00	£1,811.00	£9,055.00	Airway - Total	
4607	BACS2108 20JATI	£947.97	£157.99	£789.98	17/08/21 Cyan - Teak commemorative tree bench - Stockbridge Meadows	£947.97
		£947.97	£157.99	£789.98	Cyan - Total	
4558	BACS2108 15ELANC TY	£2,407.40	£401.23	£2,006.17	16/07/21 Elan City - MVAS Units	£2,407.40
		£2,407.40	£401.23	£2,006.17	Elan City - Total	
4554	BACS2108 17GR8	£261.60	£39.20	£222.40	16/07/21 GR8 Tool Hire Ltd - Scissor lift hire + plant insurance + collection	
4555	BACS2108 17GR8	£220.08	£36.68	£183.40	16/07/21 GR8 Tool Hire Ltd - dehumidifier + collection	£481.68
		£481.68	£75.88	£405.80	GR8 Tool Hire Ltd - Total	
4606	BACS2108 14PAA	£6,161.25	£0.00	£6,161.25	03/08/21 PAA Maintenance - Decorating - 75% of Estimate	£6,161.25
		£6,161.25	£0.00	£6,161.25	PAA Maintenance - Total	
4604	BACS2108 11DAVEY	£400.00	£0.00	£400.00	10/08/21 Paul Davey - Second-hand Batri Bike, Diamond pro Electric Bike	£400.00
		£400.00	£0.00	£400.00	Paul Davey - Total	
4578	BACS2108 05PLCOOP ER	£9,292.79	£1,548.80	£7,743.99	02/08/21 P.L. Cooper - Flooring - main area, reception, corridor, old benet room, extension rooms and store	
4579	BACS2108 05PLCOOP ER	£3,944.10	£656.35	£3,287.75	02/08/21 P.L. Cooper - Flooring - staff room, austin, first floor ext, landing and stairs	
4580	BACS2108 05PLCOOP ER	£144.00	£24.00	£120.00	02/08/21 P.L. Cooper - Flooring - plywood	£13,380.89
		£13,380.89	£2,229.15	£11,151.74	P.L. Cooper - Total	

Signature
Date

Signature

Melbourn Parish Council

August 2021 Expenditure transactions - approval list

Start of year 01/04/21

Tn no	Cheque	Gross	Vat	Net Invoice	Details	Cheque
Items Already Paid (Clerk and RFO delegated authority) contd:						
4569	BACS2108 14RE	£34.00	£0.00	£34.00	31/07/21 Royston Eco Cleaning Company - Pavilion cleaning (2 clean @ £17p/h)	£34.00
		£34.00	£0.00	£34.00	Royston Eco Cleaning Company - Total	
4556	BACS2108 05RSCAFF	£1,650.00	£275.00	£1,375.00	21/07/21 Royston Scaffolding - decoration/post construction (not part of the build budget-TU)	£1,650.00
		£1,650.00	£275.00	£1,375.00	Royston Scaffolding - Total	
4581	BACS2108 05SAKER	£3,686.88	£614.48	£3,072.40	28/07/21 Saker Computers - New server (£600 to be recharged to hub)	£3,686.88
		£3,686.88	£614.48	£3,072.40	Saker Computers - Total	
4575	BACS2108 16SCDC	£3,744.00	£624.00	£3,120.00	26/07/21 South Cambs District Council - Emptying of litter and dog bins	£3,744.00
1		£374.40	£62.40	£312.00	CON stockbridge 2 dog bins	
2		£1,872.00	£312.00	£1,560.00	PLAY Rec grounds 10 x dog and litter bins	
3		£1,497.60	£249.60	£1,248.00	PLAY Play areas 8 x dog and litter	
		£3,744.00	£624.00	£3,120.00	South Cambs District Council - Total	
4546	BACS2108 05TIMNOV	£499.53	£0.00	£499.53	08/07/21 TimNovations - Litter picking 23/04- 25/07/21 plus bicycle litter trailer (£50)	£499.53
		£499.53	£0.00	£499.53	TimNovations - Total	
Total		£60,398.00	£7,658.48	£52,739.52		

Signature
Date

Signature

Melbourn Parish Council

September 2021 Expenditure transactions - approval list

Start of year 01/04/21

Tn no	Cheque	Gross	Vat	Net Invoice	Details	Cheque
4708	BACS2109 271731LTD	£1,632.00	£272.00	£1,360.00	22/09/21 1731 Ltd - Balance of joinery Hub extension	£1,632.00
		£1,632.00	£272.00	£1,360.00	1731 Ltd - Total	
4657	BACS2109 27ARGENTA	£748.92	£124.82	£624.10	07/09/21 Argenta Tree Surveys Ltd - Tree health and safety survey and advice	£748.92
		£748.92	£124.82	£624.10	Argenta Tree Surveys Ltd - Total	
4654	DD210921 BGASORG	£9.49	£0.45	£9.04	02/09/21 British Gas - Electricity bill - old rec ground 01/08/21 - 31/08/21 - actual	£9.49
		£9.49	£0.45	£9.04	British Gas - Total	
4677	BACS2109 27CAPALC	£400.00	£0.00	£400.00	20/09/21 CAPALC - CiLCA training - assistant clerk x 5 sessions	
4678	BACS2109 27CAPALC	£150.00	£0.00	£150.00	20/09/21 CAPALC - CAPALC conference 17/09/21 - Clerk and Assistant Clerk	£550.00
		£550.00	£0.00	£550.00	CAPALC - Total	
4647	BACS2109 27CLEXPS	£11.99	£0.00	£11.99	24/08/21 Claire Littlewood - 10 x gloves for litterpickers	£11.99
4501	DD210905 DVLA	£24.06	£0.00	£24.06	05/09/21 DVLA - Parish Van road tax - instalment 6 of 12	£24.06
		£24.06	£0.00	£24.06	DVLA - Total	
4655	DD210921 EONORC	£13.32	£0.63	£12.69	06/09/21 e.On - Electricity - Orchard Road Cemetery 29/07/21- 31/08/21 Actual	£13.32
		£13.32	£0.63	£12.69	e.On - Total	
4650	DD210916 HAVEN	£2.23	£0.11	£2.12	02/09/21 Haven Power - Street lighting - unmetered supply	
4651	DD210916 HAVEN	£19.91	£0.95	£18.96	02/09/21 Haven Power - Street lighting - unmetered supply	
4652	DD210916 HAVEN	£2.50	£0.12	£2.38	02/09/21 Haven Power - Street lighting - unmetered supply	£24.64
		£24.64	£1.18	£23.46	Haven Power - Total	
4636	BACS2109 27H&CGM	£552.00	£92.00	£460.00	27/08/21 Herts & Cambs Ground Maintenance Limited - Grounds maintenance - Aug 1/12	
4637	BACS2109 27H&CGM	£487.00	£81.17	£405.83	27/08/21 Herts & Cambs Ground Maintenance Limited - Cemeteries ground maintenance - 1/12	

Signature

Signature

Date

Melbourn Parish Council

September 2021 Expenditure transactions - approval list

Start of year 01/04/21

Tn no	Cheque	Gross	Vat	Net Invoice	Details	Cheque
4638	BACS2109 27H&CGM	£747.00	£124.50	£622.50	27/08/21 Herts & Cambs Ground Maintenance Limited - Verge cutting - July (1/12)	
4639	BACS2109 27H&CGM	£906.00	£151.00	£755.00	27/08/21 Herts & Cambs Ground Maintenance Limited - Ground maintenance - recreation grounds	
4666	BACS2109 27H&CGM	£264.00	£44.00	£220.00	10/09/21 Herts & Cambs Ground Maintenance Limited - Clear and cut bank Green banks, Water Lane and hedge on High street	£2,956.00
		£2,956.00	£492.67	£2,463.33	Herts & Cambs Ground Maintenance Limited - Total	
4648	DD2110071 CO	£35.00	£0.00	£35.00	31/08/21 ICO - Data Protection Fee 2021/22	£35.00
		£35.00	£0.00	£35.00	ICO - Total	
4653	BACS21092 72LUCID	£153.00	£25.50	£127.50	01/09/21 LUCID Systems - Covered greement - October 2021	£153.00
		£153.00	£25.50	£127.50	LUCID Systems - Total	
4628	BACS2109 27HUB	£60.00	£10.00	£50.00	25/08/21 Melbourn Community Hub Management Group - Parish Office Cleaning (19 July - 16 Aug)	
4629	BACS2109 27HUB	£48.00	£8.00	£40.00	31/07/21 Melbourn Community Hub Management Group - Parish Office Cleaning (21 Jun to 12 Jul)	
4670	BACS2109 27HUB	£3,033.60	£505.60	£2,528.00	07/09/21 Melbourn Community Hub Management Group - Furniture for new rooms - Hub extension - chairs, desks	
4671	BACS2109 27HUB	£457.25	£0.00	£457.25	05/09/21 Melbourn Community Hub Management Group - FiT energy Hub solar panels 18/03/21-17/06/21	
4697	BACS2109 27HUB	£34.61	£5.77	£28.84	21/09/21 Melbourn Community Hub Management Group - Mobile Phone for Time Bank (13 Aug -12	
4699	BACS2109 27HUB	£48.00	£8.00	£40.00	21/09/21 Melbourn Community Hub Management Group - Parish Office Cleaning (23 Aug to 13 Sept)	£3,681.46
		£3,681.46	£537.37	£3,144.09	Melbourn Community Hub Management Group - Total	

Signature

Signature

Date

Melbourn Parish Council

September 2021 Expenditure transactions - approval list

Start of year 01/04/21

Tn no	Cheque	Gross	Vat	Net Invoice	Details	Cheque
4640	BACS2109 27M&M	£150.00	£0.00	£150.00	27/08/21 Mitchell & Mayle Ltd - Empty tank at pavilion	£150.00
		£150.00	£0.00	£150.00	Mitchell & Mayle Ltd - Total	
4687	BACS2109 27NORBUR YS	-£57.12	-£9.52	-£47.60	23/07/21 Norburys Building & Landscape Supplies Ltd - 2nd fix - material hub extension returned items	
4688	BACS2109 27NORBUR YS	-£22.80	-£3.80	-£19.00	04/08/21 Norburys Building & Landscape Supplies Ltd - landscaping - returned items	
4689	BACS2109 27NORBUR YS	£22.80	£3.80	£19.00	04/08/21 Norburys Building & Landscape Supplies Ltd - landscaping building materials	
4690	BACS2109 27NORBUR YS	£22.80	£3.80	£19.00	03/08/21 Norburys Building & Landscape Supplies Ltd - landscaping - Hub extension	
4691	BACS2109 27NORBUR YS	£53.10	£8.85	£44.25	27/07/21 Norburys Building & Landscape Supplies Ltd - 2nd fix building materials	
4692	BACS2109 27NORBUR YS	£39.54	£6.59	£32.95	02/08/21 Norburys Building & Landscape Supplies Ltd - 2nd fix building materials	
4693	BACS2109 27NORBUR YS	£16.20	£2.70	£13.50	03/08/21 Norburys Building & Landscape Supplies Ltd - landscaping building materials	
4694	BACS2109 27NORBUR YS	£57.00	£9.50	£47.50	04/08/21 Norburys Building & Landscape Supplies Ltd - landscaping - Hub extension	£131.52
		£131.52	£21.92	£109.60	Norburys Building & Landscape Supplies Ltd - Total	
4642	DD210901 NOW	£43.20	£7.20	£36.00	01/09/21 Now Pensions - Employer Service Charge September 2021	£43.20
4182	BACS2109 27PKF	£1,560.00	£260.00	£1,300.00	31/03/21 PKF Littlejohn LLP - Limited Assurance Review Fee AGAR 2020/21	£1,560.00
		£1,560.00	£260.00	£1,300.00	PKF Littlejohn LLP - Total	

Signature

Signature

Date

22/09/21 03:37 PM Vs: 8.61.01

Page 3

Melbourn Parish Council

September 2021 Expenditure transactions - approval list

Start of year 01/04/21

Tn no	Cheque	Gross	Vat	Net Invoice	Details	Cheque
4645	DD210923 PWLB	£6,642.79	£0.00	£6,642.79	26/08/21 Public Works Loan Board - Car park loan 2 repayments - instalment 2	£6,642.79
1		£4,356.92	£0.00	£4,356.92	F&GP Car Park Loan 2 repayment - instalment 2 principal	
2		£2,285.87	£0.00	£2,285.87	F&GP Car park Loan 2 repayment - instalment 2 interest	
4676	DD211018 PWLB	£16,477.10	£0.00	£16,477.10	20/09/21 Public Works Loan Board - Hub loan repayments - instalment 2	£16,477.10
1		£2,455.18	£0.00	£2,455.18	F&GP Hub Loan repayment - instalment 2 principal	
2		£14,021.92	£0.00	£14,021.92	F&GP Hub Loan repayment - instalment interest	
		£23,119.89	£0.00	£23,119.89	Public Works Loan Board - Total	
4698	BACS2109 27SHIRE	£1,710.00	£285.00	£1,425.00	16/09/21 Shire Trees Limited - Tree work opposite Ocharid Gate	£1,710.00
		£1,710.00	£285.00	£1,425.00	Shire Trees Limited - Total	
4674	BACS2109 27SMITHOD	£860.40	£143.40	£717.00	10/09/21 Smith Of Derby - Supply and install T1R motor with capacitor	
4675	BACS2109 27SMITHOD	£238.80	£39.80	£199.00	06/09/21 Smith Of Derby - Service of Pairsh Clock	£1,099.20
		£1,099.20	£183.20	£916.00	Smith Of Derby - Total	
4545	DD210908 WBWS	£5.50	£0.00	£5.50	20/05/21 Source for Business (Cambridge Water) - Work Shop in Car Park -	£5.50
		£5.50	£0.00	£5.50	Source for Business (Cambridge Water) - Total	
4623	DD210901 SCDCCP	£1,198.00	£0.00	£1,198.00	01/09/21 South Cambs District Council - Rates - Car park instalment 6 of 10	£1,198.00
4627	DD210901 SCDCNR	£75.00	£0.00	£75.00	01/09/21 South Cambs District Council - Rates - Victoria Way Cemetery Instalment of 10	£75.00
4417	DD210901 SCDCPAV	£38.71	£0.00	£38.71	01/07/21 South Cambs District Council - Pavillion - Fortnightly waste collection installment 3 of 9	
4625	DD210901 SCDCPAV	£259.00	£0.00	£259.00	01/09/21 South Cambs District Council - Rates - Pavilion Rec Ground Instalment 6 of 10	£297.71
		£1,570.71	£0.00	£1,570.71	South Cambs District Council - Total	

Signature

Signature

Date

Melbourn Parish Council

September 2021 Expenditure transactions - approval list

Start of year 01/04/21

Tn no	Cheque	Gross	Vat	Net Invoice	Details	Cheque
4635	BACS2109 27UNLOG OS	£70.80	£11.80	£59.00	26/08/21 Unlimited Logos - 4 bottle green polo shirts (wardens)	£70.80
		£70.80	£11.80	£59.00	Unlimited Logos - Total	
		£5,574.69	£0.00	£5,574.69	Confidential items e.g. salaries, NI & pensions	

Items Already Paid (Clerk and RFO delegated authority):

4632	BACS21 09021731L TD	£570.00	£95.00	£475.00	25/08/21 1731 Ltd - Time spent coordinating boardwalk, engineers & revising design brief prior to tender	£570.00
		£570.00	£95.00	£475.00	1731 Ltd - Total	
4658	BACS2109 09DPETTI FER	£26.73	£0.00	£26.73	27/08/21 David William Pettifer - Litter picking	£26.73
		£26.73	£0.00	£26.73	David William Pettifer - Total	
4646	BACS2109 02LUCID	£153.00	£25.50	£127.50	01/08/21 LUCID Systems - Covered greement - September 2021	£153.00
		£153.00	£25.50	£127.50	LUCID Systems - Total	
4659	BACS2109 09MWYER	£53.46	£0.00	£53.46	03/09/21 Mark Wyrer - Litter picking	£53.46
		£53.46	£0.00	£53.46	Mark Wyrer - Total	
4644	BACS2109 09PLCOOP ER	£867.60	£144.60	£723.00	02/08/21 P.L. Cooper - Repair flooring after leak in toilet	£867.60
		£867.60	£144.60	£723.00	P.L. Cooper - Total	
4656	BACS2109 14RECO	£68.00	£0.00	£68.00	31/08/21 Royston Eco Cleaning Company - Pavilion Cleaning x 4	£68.00
		£68.00	£0.00	£68.00	Royston Eco Cleaning Company - Total	
4643	BACS2109 07STRUCT ENG	£2,700.00	£450.00	£2,250.00	23/08/21 Structural Engineers Cambridge Ltd - Boardwalk - consultancy, design and detailing of walkway and viewing platform	£2,700.00
		£2,700.00	£450.00	£2,250.00	Structural Engineers Cambridge Ltd - Total	

Signature
Date

Signature

Melbourn Parish Council

September 2021 Expenditure transactions - approval list

Start of year 01/04/21

Tn no	Cheque	Gross	Vat	Net Invoice	Details	Cheque
Prepaid Debit Card Expenditure:						
4437	BACS2109 08SOLDO	£16.82	£2.80	£14.02	13/06/21 1&1 Ionos - Website Hosting	
4504	BACS2109 08SOLDO	£18.96	£3.16	£15.80	13/07/21 1&1 Ionos - Website Hosting	
4609	BACS2109 08SOLDO	£19.24	£3.21	£16.03	12/08/21 1&1 Ionos - Website Hosting	£55.02
		£55.02	£9.17	£45.85	1&1 Ionos - Total	
4573	BACS2109 08SOLDO	£21.00	£3.50	£17.50	29/07/21 Asgard - Replacement handle - storage shed - Pavilion	£21.00
		£21.00	£3.50	£17.50	Asgard - Total	
4582	BACS2109 08SOLDO	£33.40	£5.57	£27.83	06/08/21 Grassmats Ltd - Grass matting for Clear Crescent play park + delivery	£33.40
		£33.40	£5.57	£27.83	Grassmats Ltd - Total	
4559	BACS2109 08SOLDO	£102.50	£17.08	£85.42	29/07/21 Madingley Mulch - Play Area Bark - 1 cu m bag	£102.50
		£102.50	£17.08	£85.42	Madingley Mulch - Total	
4605	BACS2109 08SOLDO	£3.19	£0.00	£3.19	09/08/21 Melbourn Stores - Tea and milk	£3.19
		£3.19	£0.00	£3.19	Melbourn Stores - Total	
4565	BACS2109 08SOLDO	£3.98	£0.66	£3.32	03/08/21 Merlin Mica Hardware - Cable Clips	£3.98
		£3.98	£0.66	£3.32	Merlin Mica Hardware - Total	
4547	BACS2109 08SOLDO	£20.39	£3.40	£16.99	05/09/21 Namesco Ltd - Renewal of domain name melbourn.pc.co.uk for 2 years	
4662	BACS2109 08SOLDO	£1.00	£0.00	£1.00	02/09/21 Namesco Ltd - Charge re Renewal of domain name melbourn.pc.co.uk for 2 years	£21.39
		£21.39	£3.40	£17.99	Namesco Ltd - Total	
4520	BACS2109 08SOLDO	£47.68	£7.95	£39.73	19/07/21 Phillimore Garden Centre - Weedkiller and trug	
4634	BACS2109 08SOLDO	£5.13	£0.00	£5.13	23/08/21 Phillimore Garden Centre - Spring for gate - Ash Grove	£52.81
		£52.81	£7.95	£44.86	Phillimore Garden Centre - Total	

Signature

Signature

Date

Melbourn Parish Council

September 2021 Expenditure transactions - approval list

Start of year 01/04/21

Tn no	Cheque	Gross	Vat	Net Invoice	Details	Cheque
Prepaid Debit Card Expenditure (continued):						
4433	BACS2109 08SOLDO	£18.11	£3.02	£15.09	21/06/21 Rontec - Diesel for Parish Van	
4577	BACS2109 08SOLDO	£25.00	£4.17	£20.83	02/08/21 Rontec - Diesel for Parish Van	
4660	BACS2109 08SOLDO	£35.01	£5.83	£29.18	07/09/21 Rontec - Diesel for Parish Van	£78.12
		£78.12	£13.02	£65.10	Rontec - Total	
4649	BACS2109 08SOLDO	£123.80	£0.80	£123.00	02/09/21 Society Of Local Council Clerks - Arnold-Baker on Local Council Administration 12th Ed	£123.80
		£123.80	£0.80	£123.00	Society Of Local Council Clerks - Total	
4661	BACS2109 08SOLDO	£5.00	£0.00	£5.00	11/08/21 Soldo - Replacement debit card - wardens' lost card	£5.00
		£5.00	£0.00	£5.00	Soldo - Total	
4502	BACS2109 08SOLDO	-£0.49	-£0.08	-£0.41	11/06/21 Wrights Mower Centre - Warden's materials cable ties - price adjustment	-£0.49
		-£0.49	-£0.08	-£0.41	Wright's Mower Centre - Total	
4439	BACS2109 08SOLDO	£14.39	£2.40	£11.99	20/06/21 Zoom Video Communications Inc. - Zoom pro 20/06/2021 - 19/07/2021	
4531	BACS2109 08SOLDO	£14.39	£2.40	£11.99	20/07/21 Zoom Video Communications Inc. - Zoom pro 20/07/2021 - 19/08/2021	
4641	BACS2109 08SOLDO	£14.39	£2.40	£11.99	20/08/21 Zoom Video Communications Inc. - Zoom pro 20/08/2021 - 19/09/2021	£43.17
		£43.17	£7.20	£35.97	Zoom Video Communications Inc. - Total	
Total		£49,857.07	£3,007.11	£46,849.96		

Signature
Date

Signature

Melbourn Parish Council Financial Budget Comparison

Four Months ended 31st July 2021

Comparison between 01/04/21 and 31/07/21 inclusive. Excludes transactions with an invoice date prior to 01/04/21

	2021/22 Budget	Reserve Movements	Actual Net	Balance
INCOME				
Conservation				
100 Allotment Rent	£2,400.00	£0.00	£12.13	-£2,387.87
101 Allotment Insurance Premiums	£0.00	£0.00	£15.00	£15.00
110 CCC Grass Cutting Payment	£3,850.00	£0.00	£0.00	-£3,850.00
Total Conservation	£6,250.00	£0.00	£27.13	-£6,222.87
Cemeteries				
200 Burial Fees	£3,000.00	£0.00	£1,995.00	-£1,005.00
Total Cemeteries	£3,000.00	£0.00	£1,995.00	-£1,005.00
Play Areas & Recreation Grounds				
300 Match Fees	£2,320.00	£0.00	£140.00	-£2,180.00
320 Hire of Recreation Grounds	£100.00	£0.00	£350.00	£250.00
340 Pavilion Hire	£3,300.00	£0.00	£1,570.00	-£1,730.00
370 Pavilion Hire - MAYD recharge	£1,000.00	£0.00	£0.00	-£1,000.00
Total Play Areas & Recreation Grounds	£6,720.00	£0.00	£2,060.00	-£4,660.00
Finance & General Purpose				
410 Precept	£275,300.00	£0.00	£137,650.00	-£137,650.00
420 Interest - Deposit Account Unity	£50.00	£0.00	£0.00	-£50.00
425 Interest - Nationwide 45 Day	£350.00	£0.00	£0.00	-£350.00
430 Interest - Public Sector Deposit	£100.00	£0.00	£2.75	-£97.25
460 Miscellaneous Income	£0.00	£0.00	£1,341.00	£1,341.00
485 Feed In Tariff	£0.00	£0.00	£140.17	£140.17
Total Finance & General Purpose	£275,800.00	£0.00	£139,133.92	-£136,666.08
Highways				
Total Highways	£0.00	£0.00	£0.00	£0.00
Rental Property				
900 Little Hands Nursery Rent	£26,000.00	£0.00	£8,666.68	-£17,333.32
Total Rental Property	£26,000.00	£0.00	£8,666.68	-£17,333.32
Melbourn Area Youth Develpt Reserve				
Total Melbourn Area Youth Develpt	£0.00	£0.00	£0.00	£0.00
Community Benefit Reserve				
960 Solar Farm Grant Income	£0.00	£43,234.63	£43,234.63	£0.00
Total Community Benefit Reserve	£0.00	£43,234.63	£43,234.63	£0.00
S106 & Other Capital Grants Reserve				
141 S106 - Community Transport Service	£0.00	£55,054.95	£55,054.95	£0.00
Total S106 & Other Capital Grants Reserve	£0.00	£55,054.95	£55,054.95	£0.00
Celebrating Ages Reserve				
Total Celebrating Ages Reserve	£0.00	£0.00	£0.00	£0.00
Total Income	£317,770.00	£98,289.58	£250,172.31	-£165,887.27

Melbourn Parish Council Financial Budget Comparison

Three Months ended 31st July 2021

Comparison between 01/04/21 and 31/07/21 inclusive. Excludes transactions with an invoice date prior to 01/04/21

	2021/22 Budget	Reserve Movements	Actual Net	Balance	
EXPENDITURE					
Conservation					
1000	Allotments	£1,600.00	£0.00	£837.39	£762.61
1100	Conservation	£12,300.00	£0.00	£0.00	£12,300.00
1150	Stockbridge Meadows	£1,125.00	£0.00	£78.60	£1,046.40
1200	Grass Cutting Contract	£8,670.00	£0.00	£1,867.50	£6,802.50
1300	Public Open Space Maintenance Contract	£7,620.00	£0.00	£1,840.00	£5,780.00
Total Conservation		£31,315.00	£0.00	£4,623.49	£26,691.51
Cemeteries					
2000	Cemetery Rates, Utilities & Upkeep	£4,570.00	£0.00	£1,186.59	£3,383.41
2100	Cemetery Grounds Maintenance Contract	£6,950.00	£0.00	£1,623.32	£5,326.68
Total Cemeteries		£11,520.00	£0.00	£2,809.91	£8,710.09
Play Areas & Recreation Grounds					
3000	Play Areas	£4,200.00	£0.00	£364.79	£3,835.21
3200	Recreation Grounds	£12,475.00	£0.00	£3,210.40	£9,264.60
3400	Pavilion	£8,350.00	£0.00	£2,840.79	£5,509.21
Total Play Areas & Recreation Grounds		£25,025.00	£0.00	£6,415.98	£18,609.02
Finance & General Purpose					
4000	Audit, Legal and Professional Fees	£3,400.00	£0.00	£197.95	£3,202.05
4200	Contingency	£1,500.00	£0.00	£0.00	£1,500.00
4300	Wardens' Materials, Equipment & Van	£2,200.00	£0.00	£869.43	£1,330.57
4500	Insurances	£7,800.00	£0.00	£0.00	£7,800.00
4700	Membership of Societies	£1,340.00	£0.00	£932.03	£407.97
4900	Parish Clock	£1,350.00	£0.00	£0.00	£1,350.00
5000	Parish Office, IT & Contractors	£23,725.00	£0.00	£1,720.44	£22,004.56
5100	Salaries, NI & Pensions	£71,750.00	£0.00	£22,301.79	£49,448.21
5300	Sundry Expenses	£114.00	£0.00	£366.00	-£252.00
5400	Training	£1,500.00	£0.00	£120.00	£1,380.00
5700	Pension Scheme Charges	£440.00	£0.00	£144.00	£296.00
5900	Bank Charges	£400.00	£0.00	£46.85	£353.15
6000	Grant funding - MMWS, CRP, Grinnel Hill ins	£7,450.00	£0.00	£5,700.00	£1,750.00
6005	Grant funding - MAYD	£6,000.00	£0.00	£0.00	£6,000.00
6200	Staff & Councillor Expenses	£200.00	£0.00	£0.00	£200.00
6400	Community Hub - Grant	£15,000.00	£0.00	£15,000.00	£0.00
6401	Community Hub - Maintenance & Replacements	£6,850.00	£457.75	£577.75	£6,730.00
6402	Community Hub - Feed in Tariff	£0.00	£0.00	£140.17	-£140.17
6450	PWLB Community Hub -	£28,098.00	£0.00	£14,076.30	£14,021.70
6451	PWLB Community Hub - Capital	£4,856.00	£0.00	£2,400.80	£2,455.20
6452	PWLB Car Park - Interest	£5,632.00	£0.00	£0.00	£5,632.00
6453	PWLB Car Park - Capital	£11,255.00	£0.00	£0.00	£11,255.00
6600	Timebanking Expenses	£650.00	£0.00	£57.68	£592.32
7100	Village Car Park - Rates, Utilities & Maintenance	£14,200.00	£0.00	£5,374.36	£8,825.64
Total Finance & General Purpose		£215,710.00	£457.75	£70,025.55	£146,142.20

Melbourn Parish Council Financial Budget Comparison

Three Months ended 31st July 2021

Comparison between 01/04/21 and 31/07/21 inclusive. Excludes transactions with an invoice date prior to 01/04/21

	2021/22 Budget	Reserve Movements	Actual Net	Balance
Planning				
7000 Community Development	£5,000.00	£0.00	£150.00	£4,850.00
Total Planning	£5,000.00	£0.00	£150.00	£4,850.00
Highways				
8000 Highways and Footpaths	£3,000.00	£0.00	£0.00	£3,000.00
8100 Street Lighting	£1,750.00	£0.00	£380.77	£1,369.23
Total Highways	£4,750.00	£0.00	£380.77	£4,369.23
Rental Property				
9000 Little Hands Nursery	£1,450.00	£0.00	£905.00	£545.00
Total Rental Property	£1,450.00	£0.00	£905.00	£545.00
Melbourn Area Youth Develpt Reserve				
Total Melbourn Area Youth Develpt	£0.00	£0.00	£0.00	£0.00
Community Benefit Reserve				
9600 Community Benefit Donations	£0.00	£27,031.95	£27,031.95	£0.00
Total Community Benefit Reserve	£0.00	£27,031.95	£27,031.95	£0.00
S106 & Other Capital Grants Reserve				
1400 S106 Expenditure	£0.00	£47,548.68	£47,548.68	£0.00
1410 S106 Community Transport Service	£0.00	£5,000.00	£5,000.00	£0.00
1450 Community Capital Fund Grant - Hub Extension	£0.00	£40,766.67	£40,766.67	£0.00
Total S106 & Other Capital Grants Reserve	£0.00	£93,315.35	£93,315.35	£0.00
Celebrating Ages Reserve				
Total Celebrating Ages Reserve	£0.00	£0.00	£0.00	£0.00
Total Expenditure	£294,770.00	£120,805.05	£205,658.00	£209,917.05
Total Income	£317,770.00	£98,289.58	£250,172.31	-£165,887.27
Total Expenditure	£294,770.00	£120,805.05	£205,658.00	£209,917.05
Total Net Balance	£23,000.00		£44,514.31	

Cash and Bank Balances at 31st July 2021

Ordinary Accounts

Current Account Unity	£228,267.55
Deposit Account Unity (Instant Access)	£212,928.11
Petty Cash	£30.00
Prepaid Debit Cards	£600.00

Short Term Investment Accounts

CCLA - Public Sector Deposit fund	£25,000.00
Nationwide 45 day Business Saver	£150,691.29
Total	£617,516.95

Melbourn Parish Council Finance Report 31st July 2021

The figures above have been produced by the Parish Council's accounting system. The 'Actual' figures include receipts and payments to 31st July 2021. Adjustments for accruals and prepayments will be made at the financial year end. Where an item is funded by a reserve and does not form part of the precept budget, it is shown in the Reserve Movements column.

Variations from Budget

Income:

Pavilion Hire – the budget assumption had been that Melbourn Village College would use the Pavilion until the end of the 2020/21 academic year. They did not require use for that length of time so this budget heading is expected to be under budget.

Miscellaneous Income – includes donations of £500 for tree planting and £717 for repairs to the Parish Clock.

Gabrielle van Poortvliet – RFO Melbourn Parish Council

11th August 2021

Melbourn Parish Council Financial Budget Comparison

Five Months ended 31st August 2021

Comparison between 01/04/21 and 31/08/21 inclusive. Excludes transactions with an invoice date prior to 01/04/21

	2021/22 Budget	Reserve Movements	Actual Net	Balance
INCOME				
Conservation				
100 Allotment Rent	£2,400.00	£0.00	£12.13	-£2,387.87
101 Allotment Insurance Premiums	£0.00	£0.00	£15.00	£15.00
110 CCC Grass Cutting Payment	£3,850.00	£0.00	£0.00	-£3,850.00
Total Conservation	£6,250.00	£0.00	£27.13	-£6,222.87
Cemeteries				
200 Burial Fees	£3,000.00	£0.00	£2,530.00	-£470.00
Total Cemeteries	£3,000.00	£0.00	£2,530.00	-£470.00
Play Areas & Recreation Grounds				
300 Match Fees	£2,320.00	£0.00	£140.00	-£2,180.00
320 Hire of Recreation Grounds	£100.00	£0.00	£501.40	£401.40
340 Pavilion Hire	£3,300.00	£0.00	£1,570.00	-£1,730.00
370 Pavilion Hire - MAYD recharge	£1,000.00	£0.00	£0.00	-£1,000.00
Total Play Areas & Recreation Grounds	£6,720.00	£0.00	£2,211.40	-£4,508.60
Finance & General Purpose				
410 Precept	£275,300.00	£0.00	£137,650.00	-£137,650.00
420 Interest - Deposit Account Unity	£50.00	£0.00	£0.00	-£50.00
425 Interest - Nationwide 45 Day	£350.00	£0.00	£0.00	-£350.00
430 Interest - Public Sector Deposit	£100.00	£0.00	£3.35	-£96.65
460 Miscellaneous Income	£0.00	£0.00	£1,962.80	£1,962.80
485 Feed In Tariff	£0.00	£0.00	£140.17	£140.17
660 Timebanking Income	£0.00	£500.00	£500.00	£0.00
Total Finance & General Purpose	£275,800.00	£0.00	£140,256.32	-£135,543.68
Highways				
Total Highways	£0.00	£0.00	£0.00	£0.00
Rental Property				
900 Little Hands Nursery Rent	£26,000.00	£0.00	£10,833.35	-£15,166.65
Total Rental Property	£26,000.00	£0.00	£10,833.35	-£15,166.65
Melbourn Area Youth Develpt Reserve				
Total Melbourn Area Youth Develpt	£0.00	£0.00	£0.00	£0.00
Community Benefit Reserve				
960 Solar Farm Grant Income	£0.00	£43,234.63	£43,234.63	£0.00
Total Community Benefit Reserve	£0.00	£43,234.63	£43,234.63	£0.00
S106 & Other Capital Grants Reserve				
140 S.106 Grants	£0.00	£8,126.29	£8,126.29	£0.00
141 S106 - Community Transport Service	£0.00	£55,054.95	£55,054.95	£0.00
Total S106 & Other Capital Grants Reserve	£0.00	£8,126.29	£63,181.24	£0.00
Celebrating Ages Reserve				
Total Celebrating Ages Reserve	£0.00	£0.00	£0.00	£0.00
Total Income	£317,770.00	£106,915.87	£262,274.07	-£162,411.80

Melbourn Parish Council Financial Budget Comparison

Five Months ended 31st August 2021

Comparison between 01/04/21 and 31/08/21 inclusive. Excludes transactions with an invoice date prior to 01/04/21

	2021/22 Budget	Reserve Movements	Actual Net	Balance	
EXPENDITURE					
Conservation					
1000	Allotments	£1,600.00	£0.00	£837.39	£762.61
1100	Conservation	£12,300.00	£0.00	£0.00	£12,300.00
1150	Stockbridge Meadows	£1,125.00	£0.00	£390.60	£734.40
1200	Grass Cutting Contract	£8,670.00	£0.00	£2,490.00	£6,180.00
1300	Public Open Space Maintenance Contract	£7,620.00	£0.00	£2,300.00	£5,320.00
Total Conservation		£31,315.00	£0.00	£6,017.99	£25,297.01
Cemeteries					
2000	Cemetery Rates, Utilities & Upkeep	£4,570.00	£0.00	£1,273.38	£3,296.62
2100	Cemetery Grounds Maintenance Contract	£6,950.00	£0.00	£2,029.15	£4,920.85
Total Cemeteries		£11,520.00	£0.00	£3,302.53	£8,217.47
Play Areas & Recreation Grounds					
3000	Play Areas	£4,200.00	£0.00	£1,612.79	£2,587.21
3200	Recreation Grounds	£12,475.00	£0.00	£5,577.12	£6,897.88
3400	Pavilion	£8,350.00	£0.00	£3,492.14	£4,857.86
Total Play Areas & Recreation Grounds		£25,025.00	£0.00	£10,682.05	£14,342.95
Finance & General Purpose					
4000	Audit, Legal and Professional Fees	£3,400.00	£0.00	£197.95	£3,202.05
4200	Contingency	£1,500.00	£0.00	£0.00	£1,500.00
4300	Wardens' Materials, Equipment & Van	£2,200.00	£0.00	£893.49	£1,306.51
4500	Insurances	£7,800.00	£0.00	£0.00	£7,800.00
4700	Membership of Societies	£1,340.00	£0.00	£932.03	£407.97
4900	Parish Clock	£1,350.00	£0.00	£0.00	£1,350.00
5000	Parish Office, IT & Contractors	£23,725.00	£0.00	£3,019.79	£20,705.21
5100	Salaries, NI & Pensions	£71,750.00	£0.00	£27,876.48	£43,873.52
5300	Sundry Expenses	£114.00	£0.00	£366.00	£-252.00
5400	Training	£1,500.00	£0.00	£120.00	£1,380.00
5700	Pension Scheme Charges	£440.00	£0.00	£180.00	£260.00
5900	Bank Charges	£400.00	£0.00	£46.85	£353.15
6000	Grant funding - MMWS, CRP, Grinnel Hill ins	£7,450.00	£0.00	£5,700.00	£1,750.00
6005	Grant funding - MAYD	£6,000.00	£0.00	£0.00	£6,000.00
6200	Staff & Councillor Expenses	£200.00	£0.00	£0.00	£200.00
6400	Community Hub - Grant	£15,000.00	£0.00	£15,000.00	£0.00
6401	Community Hub - Maintenance & Replacements	£6,850.00	£457.75	£3,650.15	£3,657.60
6402	Community Hub - Feed in Tariff	£0.00	£0.00	£140.17	£-140.17
6450	PWLB Community Hub -	£28,098.00	£0.00	£14,076.30	£14,021.70
6451	PWLB Community Hub - Capital	£4,856.00	£0.00	£2,400.80	£2,455.20
6452	PWLB Car Park - Interest	£5,632.00	£0.00	£569.51	£5,062.49
6453	PWLB Car Park - Capital	£11,255.00	£0.00	£1,231.43	£10,023.57
6600	Timebanking Expenses	£650.00	£0.00	£115.36	£534.64
7100	Village Car Park - Rates, Utilities & Maintenance	£14,200.00	£0.00	£6,577.86	£7,622.14
Total Finance & General Purpose		£215,710.00	£457.75	£83,094.17	£133,073.58

Melbourn Parish Council Financial Budget Comparison

Five Months ended 31st August 2021

Comparison between 01/04/21 and 31/08/21 inclusive. Excludes transactions with an invoice date prior to 01/04/21

	2021/22 Budget	Reserve Movements	Actual Net	Balance
	2021/22 Budget	Reserve Movements	Actual Net	Balance
Planning				
7000 Community Development	£5,000.00	£0.00	£2,156.17	£2,843.83
Total Planning	£5,000.00	£0.00	£2,156.17	£2,843.83
Highways				
8000 Highways and Footpaths	£3,000.00	£0.00	£0.00	£3,000.00
8100 Street Lighting	£1,750.00	£0.00	£510.51	£1,239.49
Total Highways	£4,750.00	£0.00	£510.51	£4,239.49
Rental Property				
9000 Little Hands Nursery	£1,450.00	£0.00	£905.00	£545.00
Total Rental Property	£1,450.00	£0.00	£905.00	£545.00
Melbourn Area Youth Develpt Reserve				
Total Melbourn Area Youth Develpt	£0.00	£0.00	£0.00	£0.00
Community Benefit Reserve				
9600 Community Benefit Donations	£0.00	£27,031.95	£27,031.95	£0.00
Total Community Benefit Reserve	£0.00	£27,031.95	£27,031.95	£0.00
S106 & Other Capital Grants Reserve				
1400 S106 Expenditure	£0.00	£80,981.92	£80,981.91	£0.01
1410 S106 Community Transport Service	£0.00	£5,000.00	£5,000.00	£0.00
1450 Community Capital Fund Grant - Hub Extension	£0.00	£40,766.67	£40,766.67	£0.00
Total S106 & Other Capital Grants Reserve	£0.00	£126,748.59	£126,748.58	£0.01
Celebrating Ages Reserve				
Total Celebrating Ages Reserve	£0.00	£0.00	£0.00	£0.00
Total Expenditure	£294,770.00	£154,238.29	£260,448.95	£269,541.26
Total Income	£317,770.00	£106,915.87	£262,274.07	-£162,411.80
Total Expenditure	£294,770.00	£154,238.29	£260,448.95	£188,559.34
Total Net Balance	£23,000.00		£1,825.12	

Cash and Bank Balances at 31st August 2021

Ordinary Accounts

Current Account Unity	£131,004.47
Deposit Account Unity (Instant Access)	£162,928.11
Petty Cash	£30.00
Prepaid Debit Cards	£600.00

Short Term Investment Accounts

CCLA - Public Sector Deposit fund	£25,000.00
Charity Bank Ethical 1 Yr Fixed Term	£30,000.00
HTB 45 day Business Notice	£85,000.00
Nationwide 45 day Business Saver	£150,691.29
Total	£582,253.87

Two new investment accounts have now been opened and notice given to withdraw £50,000 from Nationwide in line with approved Investment Strategy 2021/22.

Melbourn Parish Council Finance Report 31st August 2021

The figures above have been produced by the Parish Council's accounting system. The 'Actual' figures include receipts and payments to 31st August 2021. Adjustments for accruals and prepayments will be made at the financial year end. Where an item is funded by a reserve and does not form part of the precept budget, it is shown in the Reserve Movements column.

Variations from Budget

Income:

Pavilion Hire – the budget assumption had been that Melbourn Village College would use the Pavilion until the end of the 2020/21 academic year. They did not require use for that length of time so this budget heading is expected to be under budget.

Miscellaneous Income – includes donations of £500 for tree planting and £717 for repairs to the Parish Clock.

Gabrielle van Poortvliet – RFO Melbourn Parish Council

20th September 2021

PC079/21: Report September 2021 - Community Hub Expansion

Build Progress

Work on the upgrade and expansion of the Hub building is complete. The Hub Bookmark Café reopened on August 9th 2021. The Library reopened two weeks later and is being followed by the active marketing of the new Meeting Rooms from this week onwards.

Some external works remain outstanding, with landscaping to the front, side and rear of the building still waiting for a contractor date. These residual works are being carried out in conjunction with SDC, the main contractor for the TTP-Bruntwood SciTech Science Park expansion. SDC have generously offered to carry the entire costs of the remaining external landscaping as a gift to the Community Hub and Parish Council.

The expanded and upgraded building is everything that was expected and perhaps more. Building Control sign off is in progress with an on-site visit tomorrow 28th September in conjunction with the architects to agree the Fire Safety approval details.

The project has been completed to budget. The latest Summary Spend Status Report is appended to these notes. It can be seen that an unspent balance of just over £25,000 currently remains, with a few invoices still expected. As reported at the last Parish Council meeting the Community Hub paid for the electrical installation and upgrade needed as part of the building work, intercepting these costs on behalf of the Parish Council project during the build. This arrangement was agreed as necessary for logistical and site management reasons. At the October Parish Council meeting the Community Hub will seek approval for the reimbursement of the electrical costs intercepted during the build, taking these out of the unspent balance.

Governance

Weekly Steering Meetings involving various permutations of the Clerk, RFO, MPC Chair, 1731 Ltd and Hub management were held on

14th July 2021

28th July 2021

It was agreed at the 28th July meeting, because the vast majority of the project work was complete and only a few remaining invoices were still awaited, that regular Steering Meetings would be suspended. A further meeting will take place in October to finalise the project accounts and agree in principle any transfers of funds due to the abovementioned electrical work independently paid for by the Community Hub.

There were no issues arising that required the committee to urgently refer changes to the full council for either noting or formal ratification.

Summary

Apart from a few final details, the long awaited Hub upgrade project is successfully completed. The Community Hub management would like to record their thanks and gratitude, firstly to the Melbourn Parish Council for facilitating this project, to local Councillors and District Councillors for their help and support, but also to the many partners, local businesses and individuals who have so generously given of their time and resources to making the project happen. Significant community discounts were received from many suppliers. Lastly, special thanks to the Hub staff, volunteers and directors who have given so much to create a more viable, attractive and new-look public resource for the benefit of South Cambridgeshire residents, community groups and local business.

**Hub Extension/Upgrade Project
Budget Tracking – Spend Summary September 2021**

Item	Budget	Expenditure to date	Balance Remaining	Balance %	Notes
Main Building Contractors	57,190.80	59,433.11	- 2,242.31	- 4%	Additional cost due to agreed minor scope changes.
Materials Supplies	39,615.00	38,425.26	1,189.74	3%	
Plumbing and Heating	10,819.20	2,263.58	8,555.62	79%	
Professional Services	11,100.00	11,261.67	-161.67	-1%	Added costs due to Gas Supply increased quote and further structural engineering fees.
Landscaping Works	3,900.00	3,230.00	670.00	17%	Remaining works to be carried out at SDC cost
Contingency (8.4% of total)	13,455.80	Nil	13,455.80	100%	Amended contingency from May 10 th MPC meeting
Other Costs		373.42	- 373.42	-100%	Previously incurred MPC tender advertising costs
Internal Finishing	38,191.25	34,025.18	4,166.07	11%	Global costs agreed at MPC meeting 10 th May 2021
Totals	174,272.05	149,012.22	25,259.83	14%	
Funds Available	174,272.05				Community Capital Grant, TTP s106 grant & s106 funds allocated to Hub storage works



R2 Developments
Estate Office
Lovesby Farms
Lovesby
LE7 9DD
13 September 2021

Melbourn Parish Council Clerk
Melbourn Community Hub
30 High Street
Melbourn
SG8 6DZ

Planning Application Ref: S/2424/18/FL

Development: Erection of 22 dwellings together with associated open space, landscaping, highway and drainage infrastructure works

Address: 36 New Road, Melbourn, Royston, SG8 6BY

S106 Planning Obligation Agreement 25th April 2019

**Offer to Transfer the Local Area of Play and Public Open Space to the Parish Council under
THE SECOND SCHEDULE – PART II: LAP
PART III: On-Site Public Open Space (POS)**

On behalf of R2 Developments LTD (“the Applicant” and “the Owner”) regarding the development subject to the above planning application at 36 New Road, Melbourn (“the Property”), and pursuant to THE SECOND SCHEDULE – Part II and Part III of the S106 Planning Obligation Agreement dated 25th April 2019, please accept this letter as a formal offer to transfer the ownership of the Local Area of Play and On-Site Public Open Space to the Parish Council, as shown on the attached plans (sent by email).

The Parish Council is welcome to decline the offer to transfer, whereby the obligations to maintain and own the LAP/POS would remain with the developer and the management company.

Should the Parish Council accept the offer, the Owner/Developer would still be required to maintain the LAP/POS for a minimum period of 12 months (after notice of Practical Completion) to fulfil the maintenance obligations in establishing the landscape planting under Para. 1.3.

The Owner/Developer will also be required to pay the Parish Council's reasonable and proper legal costs in relation to the transfer, as well as any SDLT.

The transfer would also trigger payment of the Local Area of Play Maintenance Contribution to the Parish Council from the Owner/Developer.

Offer Terms

The terms of the offer are defined within Part II Para. 1.13 of the agreement:

1.13 The LAP/POS shall be transferred on the following terms:

1.13.1 In the case of the transfer to the Parish Council, upon payment of consideration of £1 (one pound) and subject to the following: -

- (a) payment of the Local Area of Play Maintenance Contribution;
- (b) such transfer shall contain a restrictive covenant expressed to be for the benefit of the freehold of the remainder of the Property and each and every part thereof to the effect that the LAP/POS shall not be used for purposes other than public recreation in perpetuity; and
- (c) free from encumbrances (other than those disclosed at the date of the Agreement) together with all necessary rights of access and easements.

The Parish Council is invited to either accept or decline this offer. Should the Parish Council not accept within **30 days of this offer**, then under the terms of Part II: Para 1.12 the LAP/POS will be transferred to a Management Company (subject to written approval of the council) but always provided that fall-back arrangements are in place in plot documentation for the owners each of the Dwellings to be responsible for a proportionate part of all costs associated with on-going maintenance of the LAP/POS.

Yours sincerely

R2 Developments

(+44) 02039 076 875

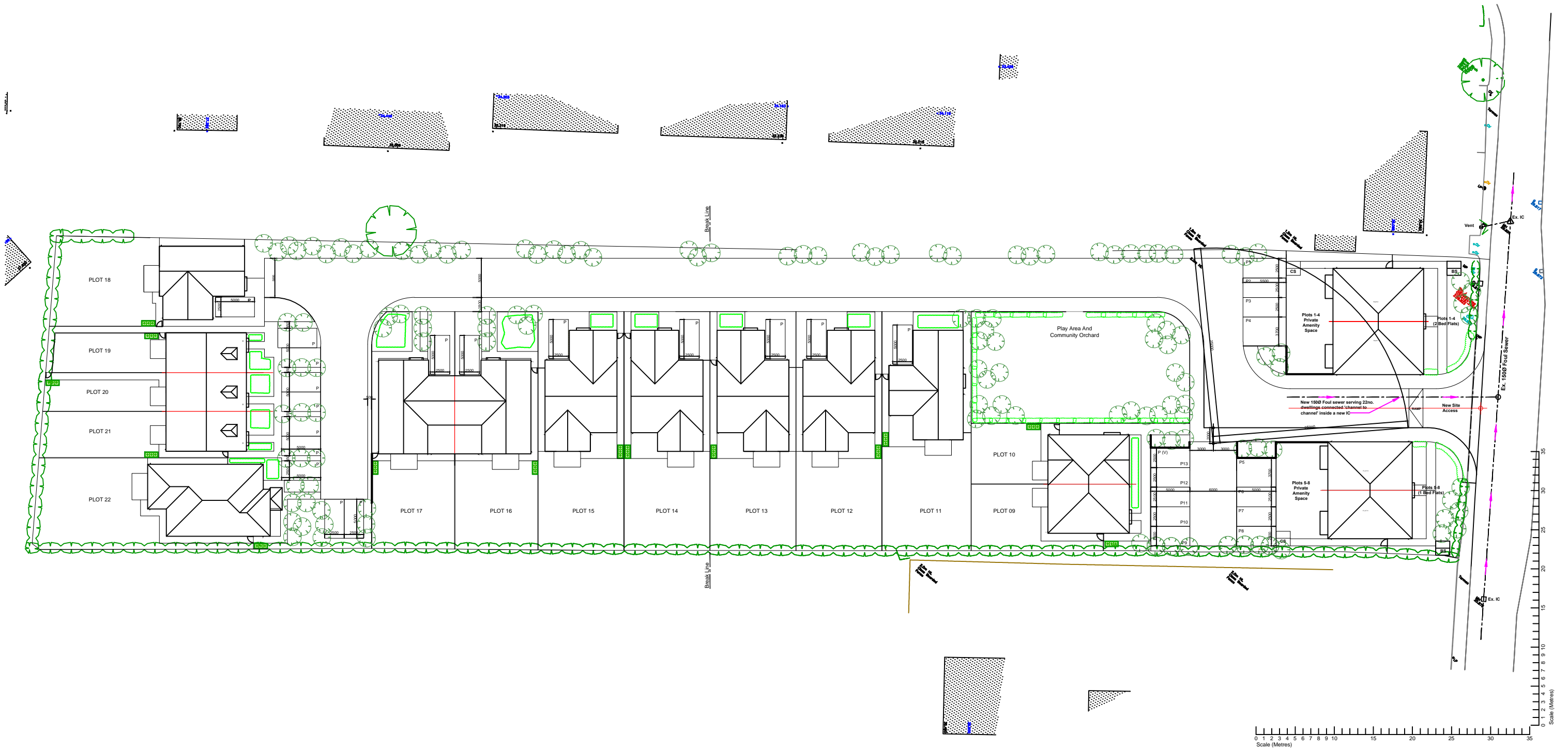

E	Revised	13.01.20
D	Plots 9-10 moved south 0.5m	06.02.19
C	Flats 1-8 revised	03.02.19
B	General Revision	25.10.18
A	Parking Spaces Amended to 2.5 x 5.0 metres	11.08.18

PCHL Barn Studio
 Lindsell Great Dunmow
 Essex CM6 3QJ
 (t) 01371 870708
 (e) office@rca-architects.co.uk

project **NEW ROAD, MELBOURN**
CAMBRIDGESHIRE scale **A3 @ 1:500**
 da **JUN 18**
 title **PROPOSED SITE PLAN** dwg no **28617.205 E**
 client **PRIME CREST HOMES LTD**

Proposed Site And Roof Plan



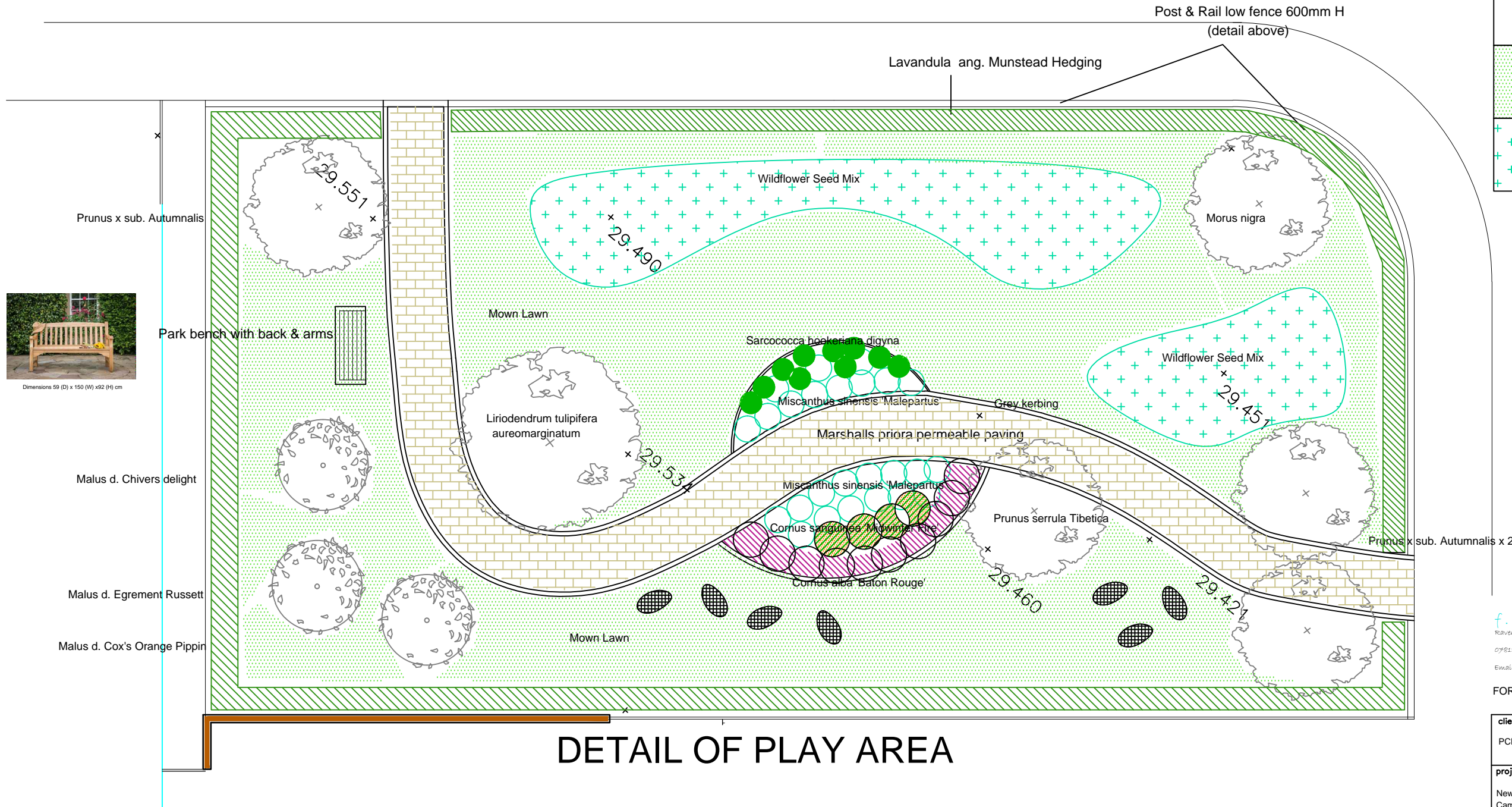
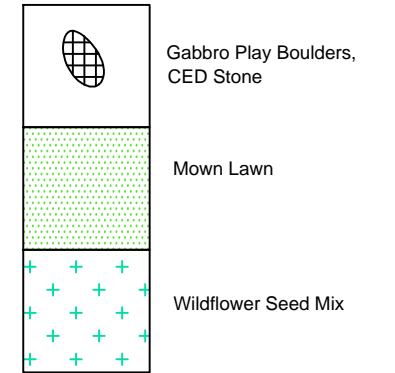
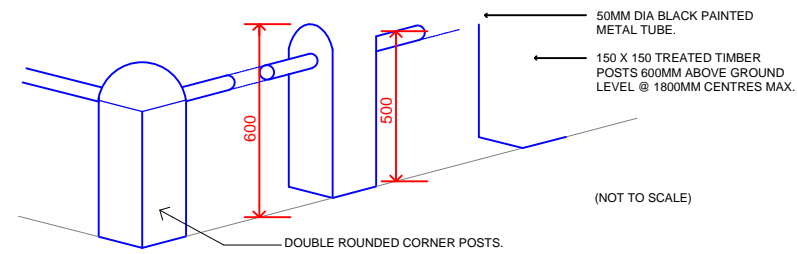
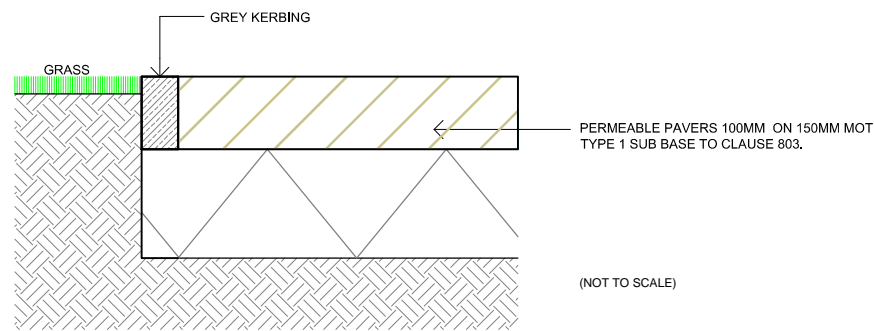

DETAIL OF PLAY AREA

f. S. Landscape & Garden Design
 Ravens Cottage, Elsenham Road, Stansted, CM24 8SS
 07818 033000
 Email - sallie.tillet@openworld.com

FOR PLANNING

client PCHL	
project New Road, Melbourn Cambridgeshire	
drawing Detail of Play Area	
date 4 June 2021	scale 1:100 @ A3
dr. no. PCHL 002 Rev 3	drawn by ST

NOTE:
 All setting out to contractor responsibility
 To be checked on site
 Design intent only
 Do not scale from drawings

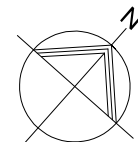
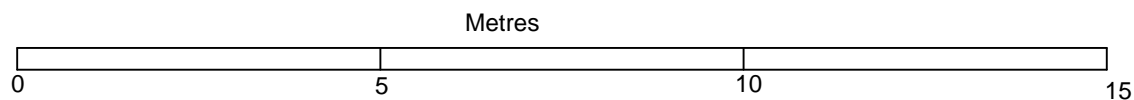

DATED

2021⁹

MELBOURN PARISH COUNCIL (1)

and

MELBOURN SCIENCE PARK LIMITED (2)

**DEED OF GRANT OF EASEMENT
FOR
FOUL SEWER CONNECTION
AT MELBOURN RECREATION GROUND ON
THE NORTH EAST SIDE OF THE MOOR, MELBOURN, ROYSTON**

Taylor Vinters LLP
Merlin Place
Milton Road
CAMBRIDGE
CB4 0DP

Tel: 01223 423444

Email: elliott.wilson@taylorvinters.com

Our Ref: EXW/43422.67

NOTE:

Annexure 1: RAMS

~~Annexure 2: Traffic Management Plan~~

Plans 1, 2 and 3

TABLE OF CONTENTS

1	INTERPRETATION	21
2	GRANT	64
3	GRANTOR'S COVENANTS	65
4	GRANTEE'S COVENANTS	65
5	HM LAND REGISTRY	65
6	INDEMNITY	76
7	JOINT AND SEVERAL LIABILITY	76
8	VAT	87
9	NOTICES	97
10	THIRD PARTY RIGHTS	108
11	GOVERNING LAW	108
12	JURISDICTION	108
	SCHEDULE 1 THE RIGHTS	1110
	SCHEDULE 2 GRANTEE'S COVENANTS	1413
	SCHEDULE 3 GRANTOR'S COVENANTS	1615

THIS DEED is dated

2021~~0~~

HM Land Registry

LAND REGISTRATION ACTS 1925 to 2002

Grantor's Title Number: CB358895

Administrative Area: Cambridgeshire: South Cambridgeshire

Grantee's Title Numbers: CB423327, CB436582 & CB95837

Administrative Area: Cambridgeshire: South Cambridgeshire

PARTIES

- 1 **MELBOURN PARISH COUNCIL** of 28 Station Road, Melbourn, Royston SG8 6DX (the "**Grantor**"); and
- 2 **MELBOURN SCIENCE PARK LIMITED** incorporated and registered in England and Wales with company number 3893143 care of TTP Group plc, Melbourn Science Park, Cambridge Road, Melbourn, Royston SG8 6EE (the "**Grantee**").

BACKGROUND

- 1 The Grantor owns the freehold interest in the Grantor's Property and the Grantee owns the freehold interest in the Grantee's Property.
- 2 The Grantee desires to lay and thereafter maintain the Pipeline and Underground Service Media in, under and through the Grantor's Property.
- 3 The Grantor has agreed to grant the easements and Rights to the Grantee for the benefit of the Grantee's Property on the terms contained in this deed.

AGREED TERMS

1 INTERPRETATION

The following definitions and rules of interpretation apply in this deed.

1.1 Definitions:

1.1.1 "**Conditions for Entry**" means the following conditions to which the Grantee and any other person exercising the Rights is subject to:-

- 1.1.1.1 effecting entry at a reasonable time (or any time in an emergency);
- 1.1.1.2 giving reasonable notice to the Grantor;
- 1.1.1.3 complying with the Grantee's Covenants set out in paragraphs 1, 2, 5 and 6 of Schedule 2; and
- 1.1.1.4 complying with reasonable health and safety requirements of the Grantor notified in writing to the Grantee.
- 1.1.2 "**Construction Access**" means the access route for construction and heavy goods vehicles, plant and machinery in connection with the carrying out of the Works and the exercise of the Rights as detailed within the RAMS shown edged green on Plan 2 and labelled accordingly.
- 1.1.3 "**Easement Strip**" means that part of the Grantor's Property being 6 metres wide shown shaded greeny on Plan 1.
- 1.1.4 "**Grantee's Covenants**" means the covenants set out in Schedule 2.
- 1.1.5 "**Grantee's Property**" means all the property at:
 - 1.1.5.1 the land known as Melbourn Science Park comprised in title number CB95837 and each and every part of it; and
 - 1.1.5.2 the land lying to the north east side of Moat Lane, Melbourn comprised in title number CB423327;
 - 1.1.5.3 the land lying to the north of Da Vinci Building, Melbourn Science Park, Cambridge Road, Melbourn comprised in title number CB436582; and
 - 1.1.5.4 to the extent only of the Grantee's ownership if any, the Unregistered Land.
- 1.1.6 "**Grantor's Covenants**" means the covenants set out in Schedule 3.
- 1.1.7 "**Grantor's Property**" means together:
 - 1.1.7.1 all the property at Melbourn Recreation Ground, Land on the North East Side of The Moor, Melbourn, Royston and each and every part of it which is registered at HM Land Registry under the title number CB358895; and
 - 1.1.7.2 to the extent only of the Grantor's ownership if any, the Unregistered Land.

1.1.8 "Losses" means claims demands damages losses and reasonably incurred costs and expenses.

1.1.9 "Pipeline" means the ~~10050~~mm vitrified clay foul sewer line or lines of pipes and/or ducts constructed or to be constructed together with any replacement pipeline the position of which is shown for identification purposes by the brown orange dashed line within the Easement Strip line on Plan 1.

1.1.10 "Plan 1" means the plan marked "Plan 1" annexed to this deed.

~~1.1.11 "Plan 2" means the plan marked "Plan 2" annexed to this deed.~~

~~4.4.12~~1.1.11 "Plan 23" means the plan marked "Plan 23" annexed to this deed.

~~4.4.13~~1.1.12 "RAMS" means the risk assessment and method statement prepared by SDC Toureen Contractors on behalf of the Grantee dated ~~2 April~~October 2020] and approved by the Grantor, a copy of which is annexed to this deed at Annexure 1.

~~4.4.14~~1.1.13 "Rights" means the rights and easements as set out in Schedule 1.

~~1.1.15 "Traffic Management Plan" means the traffic management plan annexed to this at Annexure 2 deed.~~

~~4.4.16~~1.1.14 "Underground Service Media" means any pipes (other than the Pipeline) laid or intended to be laid within the Easement Strip together with [three] manholes and all other works or apparatus identified in the RAMS or otherwise as may be necessary in connection with the Pipeline from time to time.

~~4.4.17~~1.1.15 "Unregistered Land" the land between the Grantee's Property and the Grantor's Property shown coloured white on Plan 23.

~~4.4.18~~1.1.16 "VAT" means value added tax charged under the Value Added Tax Act 1994 and any similar replacement tax and any similar additional tax.

~~4.4.19~~1.1.17 "Works" means the initial laying, erecting, constructing, installation and connection of the Pipeline and Underground Service Media in the Easement Strip in accordance with the RAMS.

1.2 Clause, Schedule and paragraph headings shall not affect the interpretation of this deed.

- 1.3 Except where a contrary intention appears, references to clauses and Schedules are to the clauses and Schedules of this deed and references to paragraphs are to paragraphs of the relevant Schedule.
- 1.4 The Schedules form part of this deed and shall have effect as if set out in full in the body of this deed. Any reference to this deed includes the Schedules.
- 1.5 A reference to laws in general is a reference to all local, national and directly applicable supra-national laws as amended, extended or re-enacted from time to time and shall include all subordinate laws made from time to time under them and all orders, notices, codes of practice and guidance made under them.
- 1.6 A reference to a statute or statutory provision is a reference to it as amended, extended or re-enacted from time to time and shall include all subordinate legislation made from time to time under that statute or statutory provision and all orders, notices, codes of practice and guidance made under it.
- 1.7 A **person** includes a natural person, corporate or unincorporated body (whether or not having separate legal personality).
- 1.8 Unless the context otherwise requires, a reference to one gender shall include a reference to the other genders.
- 1.9 Unless the context otherwise requires, words in the singular shall include the plural and in the plural shall include the singular.
- 1.10 A reference to "**Grantor**" includes its respective successors in title, personal representatives or permitted assigns and where the "Grantor" is more than one all covenants and obligations on the part of the "Grantor" shall be deemed to be joint and several;
- 1.11 A reference to "**Grantee**" includes its respective successors in title, personal representatives or permitted assigns and where the "Grantee" is more than one all covenants and obligations on the part of the "Grantee" shall be deemed to be joint and several;
- 1.12 A reference to **writing** or **written** excludes fax and e-mail.
- 1.13 Any obligation in this agreement on a person not to do something includes an obligation not to allow that thing to be done.

1.14 Any phrase introduced by the terms **including, include, in particular, for example** or any similar expression shall be construed as illustrative and shall not limit the sense of the words preceding those terms.

2 GRANT

2.1 In consideration of £5,000.00 (exclusive of VAT) (the receipt of which the Grantor acknowledges) and the covenant given by the Grantee in clause 4, the Grantor with full title guarantee grants to the Grantee the Rights in fee simple for the benefit of the Grantee's Property to the intent that the Rights shall be and remain appurtenant to the Grantee's Property and that the Rights shall be and remain a burden upon the Grantor's Property.

2.2 The Rights are granted subject to rights of the Grantor in relation to the Grantor's Property whether or not referred to in this deed.

3 GRANTOR'S COVENANTS

The Grantor covenants with the Grantee so as to bind the Grantor's Property into whoever's hands it may come, for the benefit of the Grantee's Property and each and every part of it, that the Grantor and its successors in title shall at all times observe and perform the Grantor's Covenants.

4 GRANTEE'S COVENANTS

The Grantee covenants with the Grantor for the benefit of the Grantor's Property and each and every part of it, that the Grantee, its successors in title and anyone authorised by them to use the Rights shall at all times observe and perform the Grantee's Covenants.

5 HM LAND REGISTRY

5.1 The Grantor consents to;

5.1.1 the registration of the Rights on the registered title to the Grantor's Property; and

5.1.2 any restrictive covenants entered into in this deed by the Grantor being noted against the registered title to the Grantor's Property.

5.2 As soon as reasonably practicable after completion of this deed the Grantee shall:

- 5.2.1 apply to HM Land Registry to register the Rights and to enter a notice of any restrictive covenants against the registered title to the Grantor's Property; and
- 5.2.2 apply to HM Land Registry to enter a notice of any restrictive covenants made by the Grantee in this deed against the registered title to the Grantee's Property and to enter the Rights in the Property register of the Grantee's title as appurtenant rights.
- 5.3 As soon as reasonably practicable after notification to the Grantee or the Grantee's solicitors of the completion of such registration or registrations referred to at clause 5.2 above, the Grantee shall give to the Grantor official copies of the registered titles to the Grantor's Property and the Grantee's Property, to show that the Rights and any restrictive covenants made by the Grantor and the Grantee have been properly and correctly entered against the respective titles.

6 INDEMNITY

- 6.1 The Grantee shall indemnify the Grantor and keep the Grantor indemnified against all liabilities, costs, expenses, damages and losses suffered or incurred by the Grantor arising out of or in connection with:
- 6.1.1 the exercise of the Rights;
- 6.1.2 the carrying out of any works permitted by this deed;
- 6.1.3 any breach of any of the Grantee's Covenants;
- 6.1.4 any breach of the terms of this deed;

by the Grantee, or by any occupier of the Grantee's Property or by an employee or invitee of the Grantee, or by any other person who is allowed or permitted by the Grantee to exercise the Rights.

7 JOINT AND SEVERAL LIABILITY

- 7.1 Where the Grantor comprises more than one person, those persons shall be jointly and severally liable for the obligations and liabilities of the Grantor arising under this deed. The Grantee may take action against, or release or compromise the liability of, or grant time or other indulgence to any one of those persons without affecting the liability of any other of them.

- 7.2 Where the Grantee comprises more than one person, those persons shall be jointly and severally liable for the obligations and liabilities of the Grantee arising under this deed. The Grantor may take action against, or release or compromise the liability of, or grant time or other indulgence to any one of those persons without affecting the liability of any other of them.
- 7.3 The Grantor shall not be liable to the Grantee for any failure of the Grantor to comply with the Grantor's Covenant contained in Schedule 3 unless and until the Grantee has given the Grantor notice of the facts that give rise to the failure and the Grantor has not remedied the failure within a reasonable time.
- 7.4 The Grantor is not liable for the death of or injury to the Grantee its employees, invitees or for damage to any property of theirs, or for any losses, claims, demands, actions, proceedings, damages, costs or expenses or other liability incurred by them in the exercise of the Rights.
- 7.5 Nothing in clause 7.4 shall limit or exclude the Grantor's liability for any matter in respect of which it would be unlawful for the Grantor to exclude or restrict liability.

8 VAT

- 8.1 All sums payable by the Grantee are exclusive of any VAT that may be chargeable. Subject to clause 8.3, the Grantee shall pay VAT in respect of all taxable supplies made to it in connection with this deed on the due date for making any payment or, if earlier, the date on which that supply is made for VAT purposes.
- 8.2 Every obligation on the Grantee, under or in connection with this deed, to pay the Grantor any sum by way of a contribution, refund or indemnity, shall include an obligation to pay an amount equal to any VAT incurred on that sum by the Grantor, except to the extent that the Grantor obtains credit for such VAT under the Value Added Tax Act 1994.
- 8.3 The Grantee shall not be required to make any payment of VAT unless and until the Grantor provides the Grantee with a valid VAT invoice addressed to the Grantee.

9 NOTICES

- 9.1 Any notice given under this agreement must be in writing and signed by or on behalf of the party giving it.
- 9.2 Any notice or document to be given or delivered under this agreement may be given by delivering it personally or sending it by pre-paid first class post, or recorded delivery to the address and for the attention of the relevant party as follows:
 - 9.2.1 to the Grantor at Melbourn Parish Council at 28 Station Road, Melbourn, Royston SG8 6DX marked for the attention of the Parish Clerk or to such other address as may be notified by the Grantor to the Grantee from time to time as being its address for service; and
 - 9.2.2 to the Grantee at Melbourn Science Park, Cambridge Road, Melbourn, Royston SG8 6EE marked for the attention of the Company Secretary or to such other address as may be notified by the Grantee to the Grantor from time to time as being its address for service.
- 9.3 Any notice or document served in accordance with this clause 9 will be deemed to have been received:
 - 9.3.1 if delivered personally, at the time of delivery provided that if delivery occurs before 9.00 am on a working day, the notice will be deemed to have been received at 9.00 am on that day, and if delivery occurs after 5.00 pm on a working day, or on a day which is not a working day, the notice will be deemed to have been received at 9.00 am on the next working day; and
 - 9.3.2 in the case of pre-paid first class or recorded delivery post, at 9.00am on the first working day after posting.
- 9.4 In proving delivery, it will be sufficient to prove that delivery was made or that the envelope containing the notice or document was properly addressed and posted as a prepaid first class, or recorded delivery letter or special delivery letter was properly addressed, as the case may be.
- 9.5 A notice or document delivered under this agreement shall not be validly given or delivered if sent by e-mail or fax.

10 THIRD PARTY RIGHTS

A person who is not a party to this deed shall not have any rights under the Contracts (Rights of Third Parties) Act 1999 to enforce any term of this deed.

11 GOVERNING LAW

This deed and any dispute or claim arising out of or in connection with it or its subject matter or formation (including non-contractual disputes or claims) shall be governed by and construed in accordance with the law of England and Wales.

12 JURISDICTION

Each party irrevocably agrees that the courts of England and Wales shall have exclusive jurisdiction to settle any dispute or claim arising out of or in connection with this deed or its subject matter or formation (including non-contractual disputes or claims).

THIS AGREEMENT has been entered into as a deed on the date stated at the beginning of it.

SCHEDULE 1

The Rights

Subject to the Grantee complying with the Conditions for Entry and the [RAMSTraffic Management Plan](#), the full right and liberty for the Grantee and the Grantee's successors in title as owners or occupiers for the time being of the Grantee's Property and its officers, servants and agents and others authorised by it at all times and for all purposes connected with the lawful use and enjoyment of the Grantee's Property whether now or in the future to:

Right to reposition football pitch

~~1.1 undertake such works on the Grantor's Property to reposition the football pitch outside of the Easement Strip (as may be reasonably necessary for carrying out the Works) in the location shown marked out on Plan 1 PROVIDED THAT following completion of the Works should the Grantor reasonably request that the football pitch be reinstated to the position it is in at the date of this deed, the Grantee shall procure (at the Grantee's cost) the works necessary to reinstate the football pitch in a proper and workmanlike manner to the reasonable satisfaction of the Grantor;~~

Right to erect temporary fencing and water-filled barriers

~~4.21.1 erect and install temporary fencing and water-filled barriers for the duration of the Works on the Grantor's Property in the locations as detailed in the RAMS shown ~~by a red dashed line on Plan 2;~~~~

Right to construct and maintain etc Pipeline

~~4.31.2 undertake the Works and to lay erect construct inspect maintain renew replace repair test cleanse- make incapable of operation or remove any part or parts of the Pipeline and Underground Service Media in the Easement Strip together with the right of having and enjoying the use and free flow and passage of water and sewerage with or without other matter of any kind whatsoever through and by means of the Pipeline and Underground Service Media;~~

~~4.41.3 excavate and open up so much of the Easement Strip and to carry out the Works and such other works thereon as may be reasonably required for the purpose of exercising or in connection with the exercise of any of the Rights;~~

~~4.51.4~~ temporarily place on the Construction Access, the Easement Strip and that part of the Grantor's Property shown edged orange on the plans forming part of the RAMS hatched green on plan [...] or such other parts of the Grantor's Property agreed with and approved by the Grantor from time to time (such approval not to be unreasonably withheld or delayed) any such plant and materials required to be used in connection with the purposes above mentioned

Rights of temporary storage of soil

~~1.6~~ temporarily store (for the duration of the Works) top soil excavated during the Works on the Grantor's Property in the location marked ["potential area for topsoil storage during construction works"] on Plan 1;

Rights of access

~~4.71.5~~ with or without contractors surveyors employees and others and with or without motor or other vehicles plant equipment apparatus and materials at all reasonable times to enter upon the Construction Access and those parts of the Grantor's Property shown edged blue and orange on the plans forming part of the RAMShatched green on plan [...] or such other parts of the Grantor's Property agreed with and approved by the Grantor from time to time (such approval not to be unreasonably withheld or delayed) necessary to carry out the Works and for the purpose of exercising or in connection with the exercise of any of the Rights;

Right to maintain manhole covers

~~4.81.6~~ construct maintain replace renew and use three manhole covers and inspection chambers required to facilitate inspection and maintenance of the Pipeline and the Underground Service Media in such locations identified by the RAMS;

Right of support

~~4.91.7~~ continuous vertical and lateral support and protection for the Pipeline and the Underground Service Media and the Easement Strip;

Right of line walking

~~4.101.8~~ enter upon the Grantor's Property at any time on giving a minimum of 48 hours' prior written notice (save in the case of emergency) for the purposes of walking

the line of the Easement Strip, the Pipeline and or examining and inspecting the Pipeline and the Underground Service Media; and

Right to remove trees

[4.441.9](#) fell, trim or lop any trees, bushes and other vegetation or scrub growth or the roots of which may grow in on over or under the Easement Strip which obstruct or interfere with the exercise of the rights granted to the Grantee by this deed subject to the Grantee providing the Grantor with 10 days' prior written notice and provided that the Grantee removes from the Grantor's Property all timber, wood and vegetation cut and leaves the Grantor's Property neat and tidy.

SCHEDULE 2

Grantee's covenants

The Grantee shall:

1 STATUTORY REQUIREMENTS

when exercising the Rights (including when carrying out the Works), comply with all laws governing the installation and use of the Underground Service Media;

2 MAKING GOOD OF DAMAGE ETC

at all times to take all reasonable and proper precautions to ensure that in the exercise of the Rights and carrying out the Works as little damage as is reasonably practicable is caused to the Easement Strip or that part of the Grantor's Property over which the Rights are exercised and any turf thereon or drains thereunder and to make good any damage caused as soon as reasonably practicable to the reasonable satisfaction of the Grantor or pay reasonable compensation to the Grantor for any Losses suffered by them by reason of the exercise of the Rights except to the extent that such Losses result from the neglect or default of the Grantor or others authorised by them and FOR THE AVOIDANCE OF DOUBT the Grantee shall replace any trees materially damaged with a similar species of tree in carrying out the Works and exercising its Rights in accordance with this deed;

3 ASSIGNMENT

not assign the benefit of this deed except to a third party who shall first covenant (by way of a deed of covenant in a form approved by the Grantor (such approval not to be unreasonably withheld or delayed)) on behalf of itself and its successors in title with the Grantor to comply with the obligations of the Grantee in this deed;

4 INDEMNITY

keep the Grantor indemnified against all actions claims or demands arising by reason of the exercise of the Rights (except any such actions claims or demands as may be occasioned by the default or wrongful act of the Grantor or the Grantor's servants or agents) PROVIDED THAT the indemnity is conditional upon the Grantor (i) giving to the Grantee written notice of any such actions

claims or demands as soon as possible after the Grantor becomes aware of any such actions claims or demands; (ii) taking all reasonable steps to mitigate any liabilities relating to such actions claims or demands; and (iv) keeping the Grantee reasonably informed in relation to the material progress of any such actions, claims and demands.

5 NUISANCE

not cause any nuisance, annoyance or disturbance to the Grantor or occupiers of the Grantor's Property, or of any neighbouring land, or to any other person entitled to the Rights in common with the Grantee.

6 RAMSTRAFFIC MANAGEMENT PLAN

when exercising the Rights (including when carrying out the Works), comply with the RAMSTraffic Management Plan.

SCHEDULE 3

Grantor's covenants

The Grantor shall:

1 INTERFERENCE WITH UNDERGROUND SERVICE MEDIA

not do anything or knowingly allow anything to be done on the Grantor's Property that may interfere with or damage the Pipeline or Underground Service Media or interfere with, impede or obstruct the Grantee's access to or use of them and/or interfere with, impede or prevent the Grantee's exercise of the Rights PROVIDED THAT if such interference, obstruction or damage is caused the Grantor shall upon receiving written notice of the same from the Grantee as soon as reasonably possible make good any damage caused and / or take such preventative measures as are necessary in respect of such interference and / or obstruction in each case to the Grantee's reasonable satisfaction.

2 CONSTRUCTIONS ON EASEMENT STRIP

not cause permit or suffer the erection or installation of any building structure or apparatus or to carry out any development or excavation on or beneath the Easement Strip;

3 TREES

not plant or otherwise permit to exist any trees or shrubs on the Easement Strip or in such a location so that the roots thereof are within the Easement Strip;

4 FURTHER EASEMENT

not grant any further easement or licence in on under or affecting any part of the Easement Strip without the prior written consent of the Grantee which may not be unreasonably withheld or delayed;

5 ALIENATION

5.1 not sell convey transfer lease grant mortgage charge or dispose of or otherwise encumber the Easement Strip and so much of the Grantor's Property as is reasonably required for the exercise of the Rights or any part thereof unless such conveyance transfer lease mortgage or disposition is expressed to be subject to the Rights and the other provisions of this deed and:

5.1.1 in the case of a transfer lease or other disposition (except a mortgage) contains covenants on the part of the purchaser transferee tenant or disponee to observe and perform the provisions of this Schedule 3; and

5.1.2 in the case of a mortgage contains covenants on the part of the mortgagee to observe and perform the provisions of this Schedule 3 but with effect only during such time (if any) as it shall have entered into possession of the Easement Strip and so much of the Grantor's Property as is reasonably required for the exercise of the Rights or any part thereof so that it shall not be personally liable after it shall have parted with all its interest in the Easement Strip and so much of the Grantor's Property as is reasonably required for the exercise of the Rights or any part thereof; and

6 INDEMNITY

indemnify the Grantee against all costs, losses and expenses, and all claims or demands lawfully brought or made against it, by reason of any breach of this Schedule 3.

**EXECUTED as a DEED by
MELBOURN PARISH COUNCIL**

acting by

COUNCILLOR [...]

As Councillor of Melbourn Parish Council

COUNCILLOR [...]

As Councillor of Melbourn Parish Council

Witnessed by [...]

As Clerk of Melbourn Parish Council

Signature of Witness

Name (in BLOCK CAPITALS)

Address:

**EXECUTED as a DEED by
MELBOURN SCIENCE PARK LIMITED**

acting by a director in the presence of:

Signature of Witness

Name (in BLOCK CAPITALS)

Address:



LIMEGROVE HOUSE
CAXTON ROAD
BEDFORD
MK41 0QQ

ISO:45001:2018
ISO 14001:2015
ISO 9001: 2015

RAMS

OFFSITE DRAINAGE WORKS

PROJECT:	Project Birchwood, Land North of Melbourn Science Park
ADDRESS:	Cambridge Rd, Melbourn, Royston SG8 6EE
CLIENT:	Melbourn Science Park Limited
REFERENCE:	B1910 – TF – REP - 020

INTRODUCTION

This Principal Contractor's Method Statement is intended to detail the scope of work and the methodology for the installation of the offsite foul water drainage for Project Birchwood. It outlines the sequence of operations, programme of works and risk mitigation principles. SDC intend to undertake these works in Autumn 2021, subject to authorisation by Anglian Water and the Lead Local Drainage Authority.

This operation is challenging because it involves the installation of a foul water drainage pipe through a recreation ground which is used by multiple sports teams and is open to unhindered access by the public. This increases the risk of nuisance to these users and more importantly a potential safety hazard for users / trespassers into these work areas.

The first step of risk mitigation is to design out as much of the hazard as possible. Following numerous risk mitigation workshops, TTP have instructed SDC to proceed based on a shallower pumped drainage solution. This has three key benefits:

1. Much shallower drainage pipework, not reliant on gravity, meaning the installation process is quicker and safer to execute.
2. Drainage pipework can be laid more flexibly, meaning the encroachment on the existing football pitch is minimised.
3. The installation of a pumping chamber within the curtilage of the Birchwood site means that the capacity of the chamber can be utilised for construction-phase effluent management, meaning there is less pressure on the installation programme.

This method statement sets out the intended process for safely installing the drainage pipework through the Parish Council's property.

1. DESCRIPTION OF WORKS

Installation of foul water drainage pipework from the Project Birchwood outfall position to an existing Anglian Water pipe within the Parish Council Recreation Ground. **Access to the location will be via the Birchwood construction site, not The Moor.**

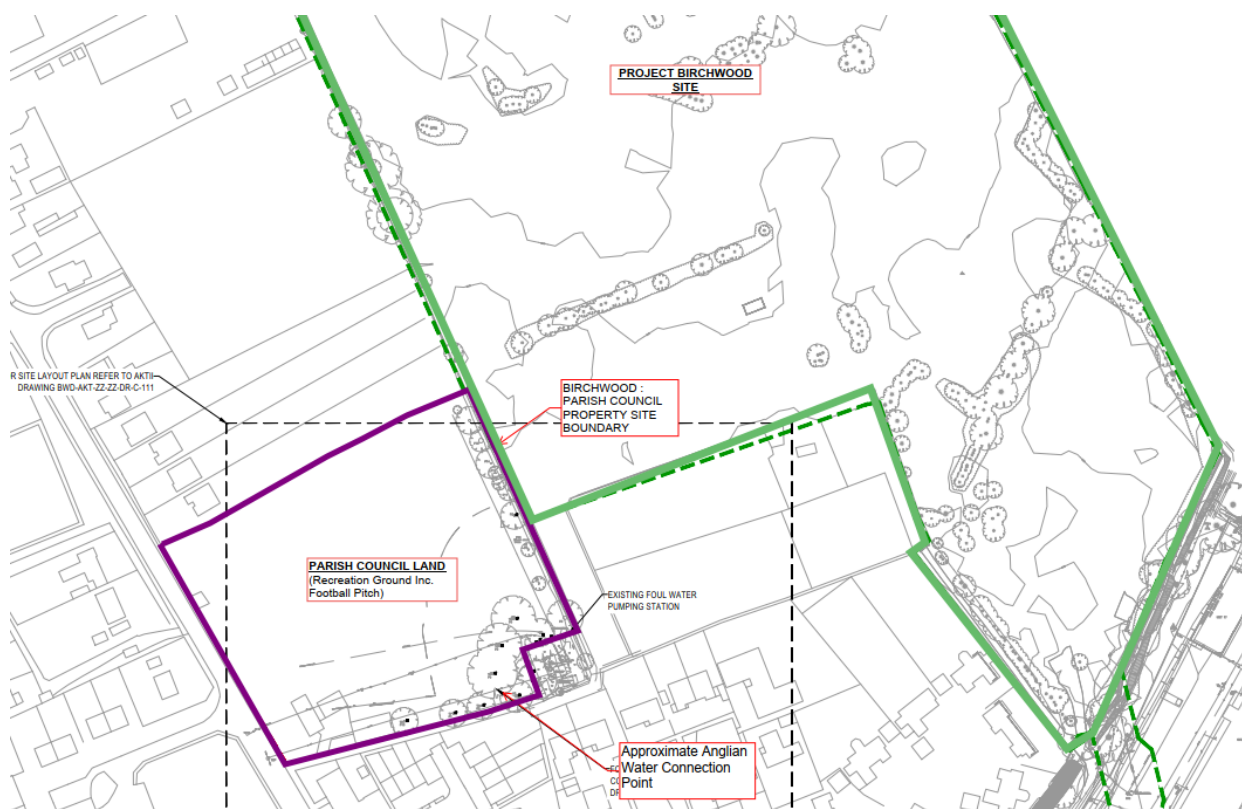

Figure 1 - Overview of Properties and Connection Point

The works are to be carried out by SDC's subcontractor, Oliver Connell & Son who will adhere to the contents of this works methodology when producing detailed works proposals.

The pipe will be brought under the existing swale at the Western extent of the Birchwood site and diverted across the recreation ground before entering a receiving chamber and dropping in to the Anglian Water primary main.

2. RELEVANT DRAWINGS / DESIGN

The detailed design is currently under development and is subject to approval by Anglian Water. SDC's engineer, Scott, White & Hookins, are developing the design based on the appended information as follows:

BWD-SWH-ZZ-XX-DR-D-0532 (P02) – Off-Site Drainage Scheme: Pumped Solution

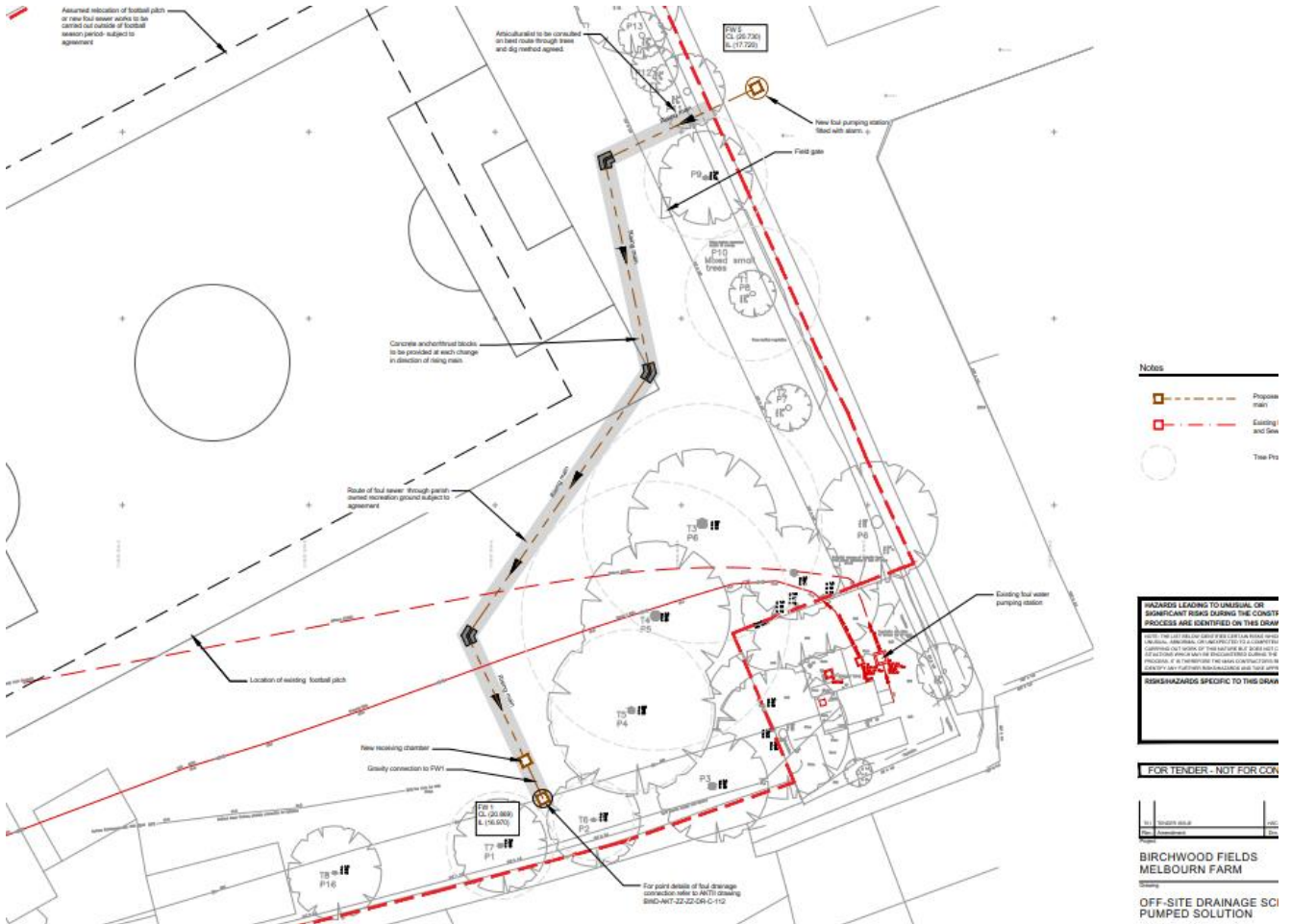
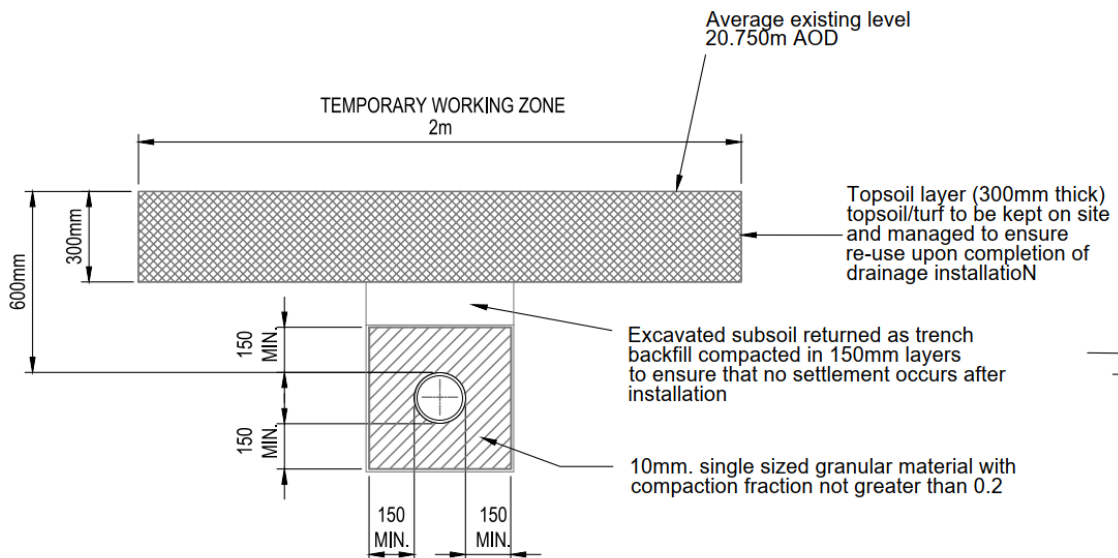

Figure 2 - Extract from plan drawing showing worst-case impingement on to the football pitch.

The design attempts to install the pipe with the minimum encroachment on the football pitch position.

The following section detail demonstrates that the crown of the pipe will be 600mm below the pitch surface. Previously this was more than 3M below the surface. This helps us to reduce the width of the working area and therefore the consequential damage to turf and improve the programme period:



The chosen sequence (see below section) minimises the nuisance period near the football pitch and would hopefully mean not having to move the pitch at all following further clarification with the parish council.

3. TRAFFIC MANAGEMENT PLAN & LOGISTICS ARRANGEMENTS

The following key principles for accessing the works and moving materials will be followed.

- **All access, deliveries, plant and personnel movements will be strictly from the Birchwood site via a culvert over the existing swale. No access will be required from The Moor, with the exception being during the overpumping period during the final week of access (see below phasing plan)**
- The site working hours as outlined within the planning permission (ie 0800-1800 mon-fri) will strictly be followed. No Saturday working will be implemented if this clashes with the football season/fixtures.
- A temporary culvert will be installed over the existing swale at the boundary, consisting of a 300mm concrete pipe backfilled with engineered stone installed on a geotextile membrane to permit crossing of the swale for pedestrians and vehicles. A temporary culvert license / permit will be obtained from the lead local drainage authority for this.



Fencing:

The following two fencing types will be used – these are shown on the phasing plans in section 4.

1 – Heras Fencing

This fencing will be used during temporary applications and is used for the boundary of the Birchwood Project Site. This is noted in blue on the sequence plans:



2 – Water-Filled Barriers with Mesh Fence Panel



WEEK 2 – Continuation of Drainage Installation – Optional adjustment of football pitch position

- **Relocation of the football pitch to the hatched position is not required.**
- Careful removal of existing turf to enable quick reinstatement.
- Installation an adequate amount of drainage pipework and thrust blocks to permit full reinstatement of the turf by the end of the week and pull the barriers back away from the football pitch before the weekend.
- Relocation of the fencing off the football pitch if needed, depending on the outcome of engagement with the Parish Council.
- **IMPORTANT:** We intend to reduce the working area where it crosses the football pitch down to 1.2m width and we intend to replace the turf removed within 36 hours and re-roller to prevent damage to the football pitch. A specific detail is shown below the plan.

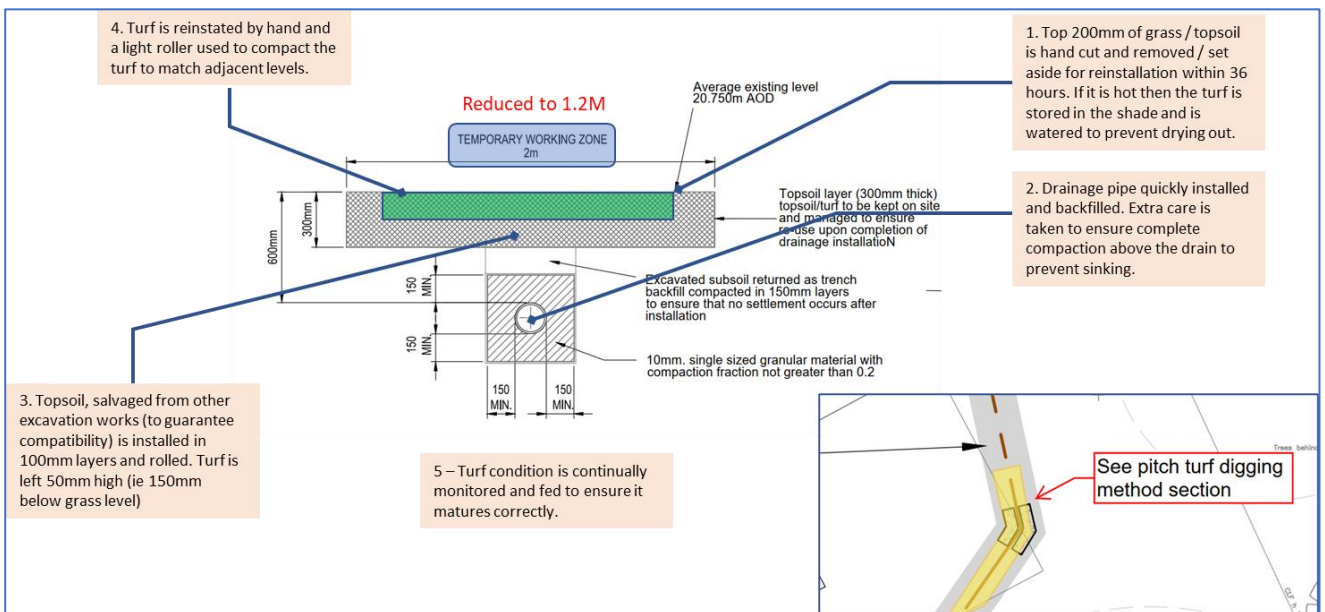
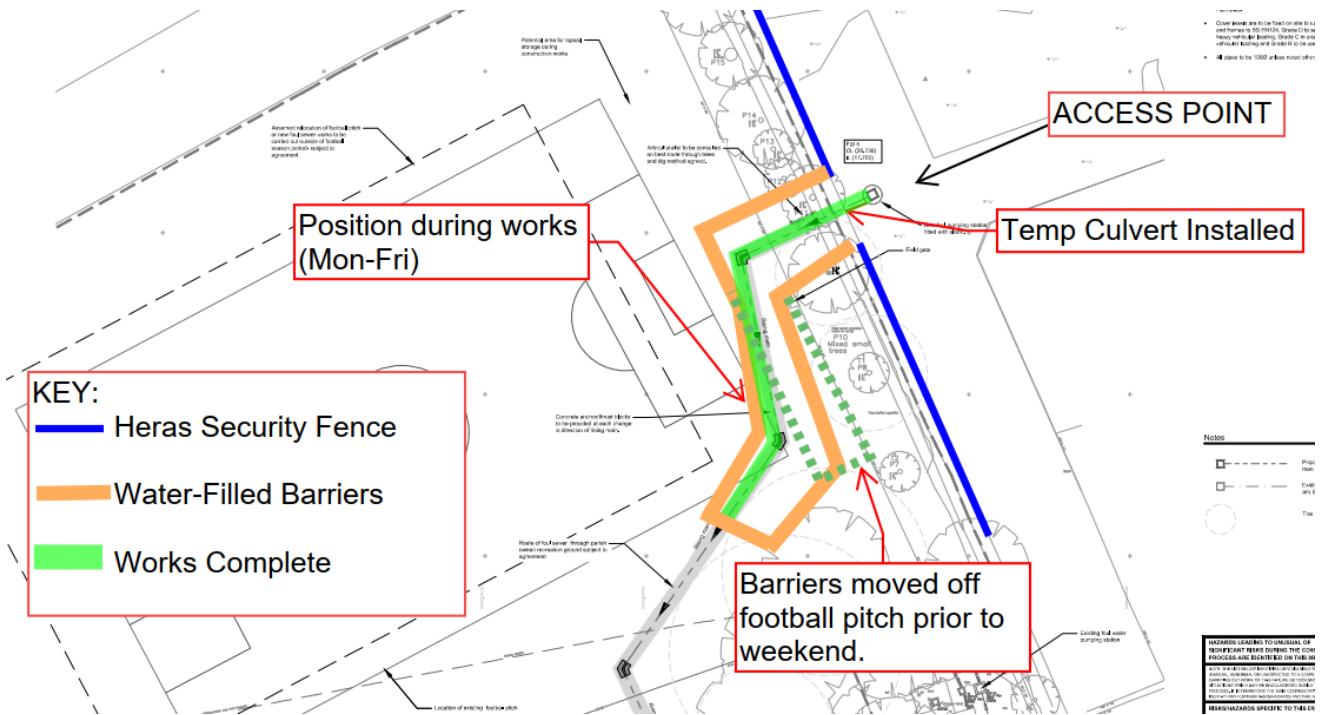
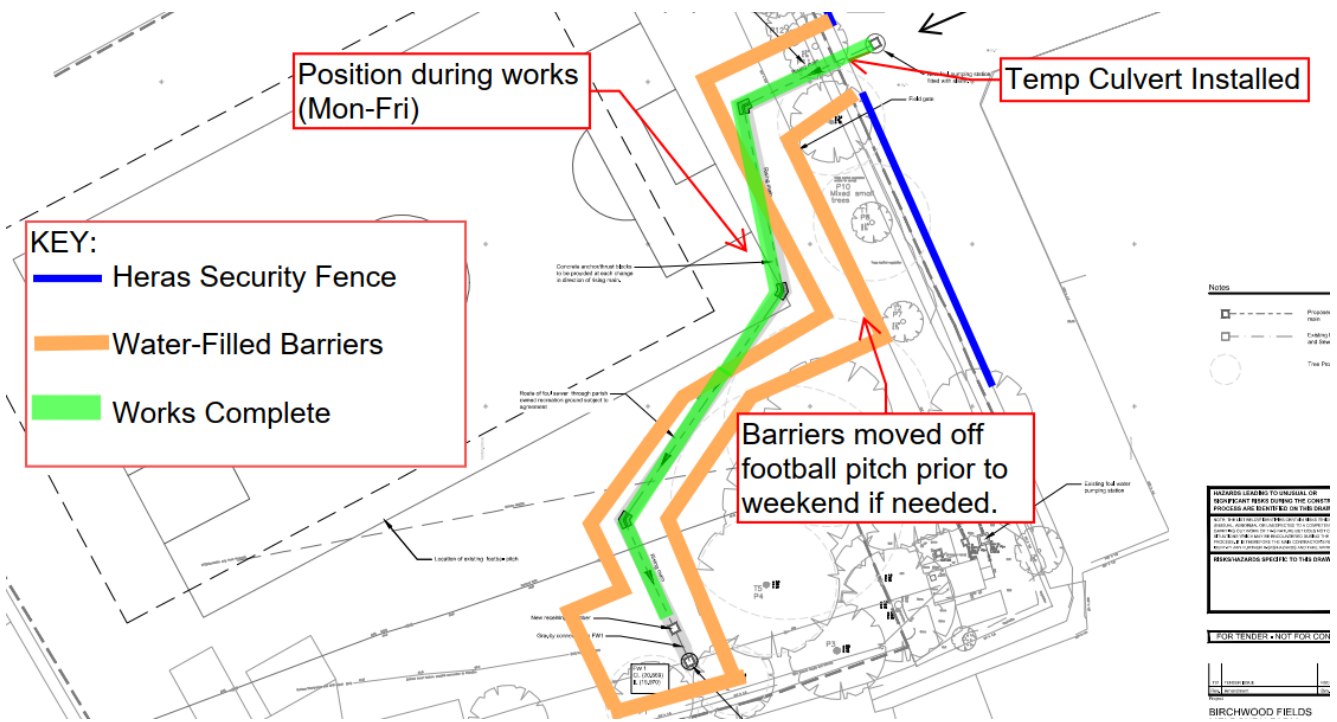

Figure 3 - Detail for where the pipe crosses the football pitch.

WEEK 3 – Completion of Primary Drainage Runs and Establishment of Chamber / Connection Site

- Most of the drainage installation will be concluded this week and a small satellite site will be established around the connection point and manhole as shown.



WEEK 4 – Connection to the Anglian Water Network

- The connection process is subject to Anglian Water's approval and so the precise programme for this phase cannot be guaranteed, however the construction of the two manholes will be undertaken during week 4 and an over-pumping arrangement, approved by Anglian Water and agreed logistically with the Parish Council will need to be implemented for a period of 5 days during the break-in to the Anglian Water pipe. SDC propose that these works are undertaken during the half-term at Melbourn Village College to minimise disruption. SDC's traffic management plan for The Moors will be submitted to the Parish Council prior to implementation to obtain comment.

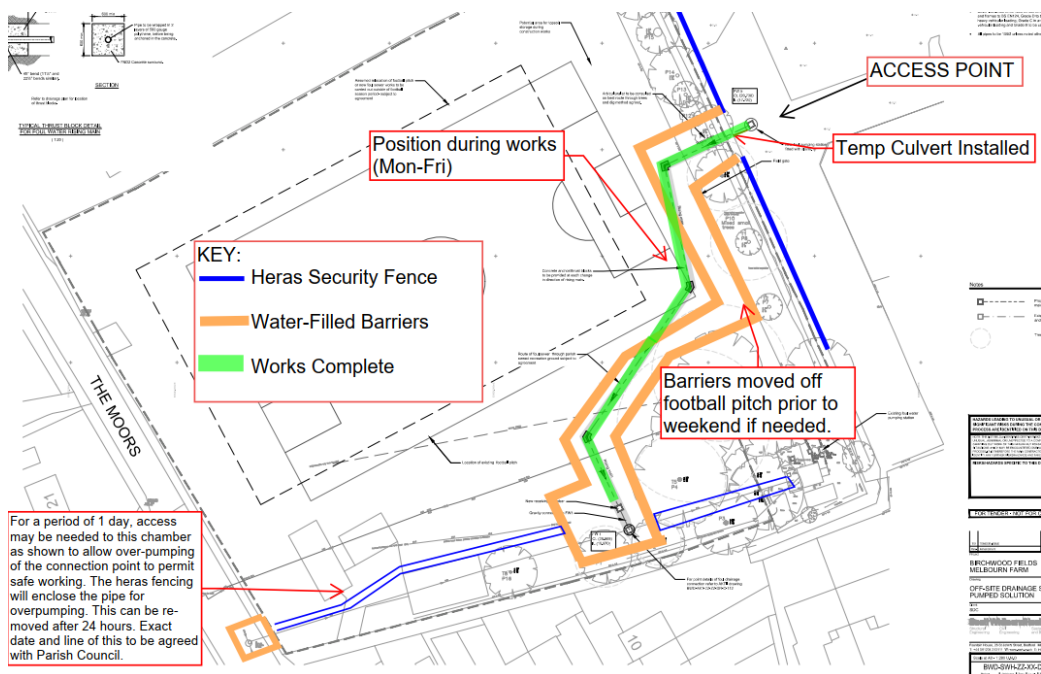

WEEK 5 – Demobilisation

- Removal of all fencing and re-instatement of topsoil and turf, returned to the condition found and recorded within the condition survey.
- CCTV survey of the installed mains and approval from Anglian Water that works have been completed.

5. REINSTATEMENT CONDITION

SDC are very aware of the importance of retaining the integrity of the existing turf / surfacing. We will salvage all of the topsoil during the works and reinstate to ensure compatibility. New turf will be laid wherever required (no seeding). Should turf need establishment time, following demobilisation, stake and mesh fencing will be installed around these areas and they will be watered and maintained by SDC while the turf is established. We will reinstate this to the satisfaction of the parish council.

6. SUPERVISION

These works will be supervised by:

- Philip Moore – Site Manager - Contact Number: 07500 840958
- Tom Fenner – Project Manager – Contact Number: 07831 165880

Our subcontractor, Oliver Connell & Son will have a competent site team, however Phil and Tom are the primary points of contact for the works.

7. MONITORING ARRANGEMENTS

SDC will issue a weekly situation report to Councillor Steve Kilmurray and Claire Littlewood via email during the works to provide an update on progress.

8. PLANT & EQUIPMENT

Due to the shallow nature of the excavation, we will be using small excavators to undertake these works. They will be accompanied by a dumper and a roller to ensure adequate compaction of the subsoil prior to reinstatement of the surfacing.

9. SAFETY OF THIRD PARTIES

Safety of third parties is the principal objective here. We believe we have designed out a significant portion of the risk by reducing the duration and extent of the works. Notwithstanding this we have produced the following summary risk assessment to confirm how this plan addresses the safety of third parties:

Hazard Description	Potential Consequence	Mitigation Measure
<u>Persons injured trying to access the work area to retrieve footballs etc.</u>	Falling from height or cuts and abrasions caused by stepping on hazards with inappropriate footwear.	Fencing to be water-filled (immovable) fence with mesh panel over. This creates a vision line over the fence to aid hazard perception. SDC have considered putting mesh over the site when not in operation however this may encourage dangerous climbing. Plant and equipment to be brought back into the main site area out-of-hours.
<u>Turf reinstated incorrectly, causing musculoskeletal injuries when playing sports.</u>	Sports Injuries	Turf to be reinstated to the satisfaction of the parish council. The reinstatement time and permitted re-use is dependent on the season and the constraints of the fixtures etc and needs to be considered with the Parish Council.
<u>Damage to trees</u>	Trees dying or becoming unstable.	The drainage run avoids the root protection areas for the trees. SDC will engage the

		services of an arboriculturist to verify our intended drainage route on site prior to commencement.
<u>Traffic nuisance when accessing manhole on The Moor</u>	Traffic Accident	Agree the principles of accessing this chamber with Anglian Water and install Chapter 8 compliant barriers and signage in accordance with the National Road and Streetworks Act.
<u>Fencing is insecure and blows over in the wind</u>	Unauthorised access into a dangerous environment.	Water-filled barriers selected because they are immovable.
<u>Collision with fencing during football game</u>	Personal injuries	Water-filled barriers are selected because they are safer than Heras fencing if collided with and less likely to cause abrasions and personal injury. We will keep the barriers as far away as possible from the perimeter of the pitch.

10. EMERGENCY PROCEDURES

In the event of an emergency only, SDC propose that the emergency services are directed to this work location via the exit from The Moors. Access to the field is via a padlocked gate and SDC will obtain a key for this gate, only to be used in the event of emergency.

11. PROGRAMME

The works duration is outlined in the above sequence of operations (section 4) which show a duration of 4-5 weeks for the works.

The timescales are not project-critical. That is because we can use the pumping station to facilitate the construction phase and hence, we can be flexible around the football season to minimise nuisance caused. We would welcome a programme discussion with the Football Club and Parish Council to finalise this. See below a suggestion of the proposed programme following approval of the RAMS.

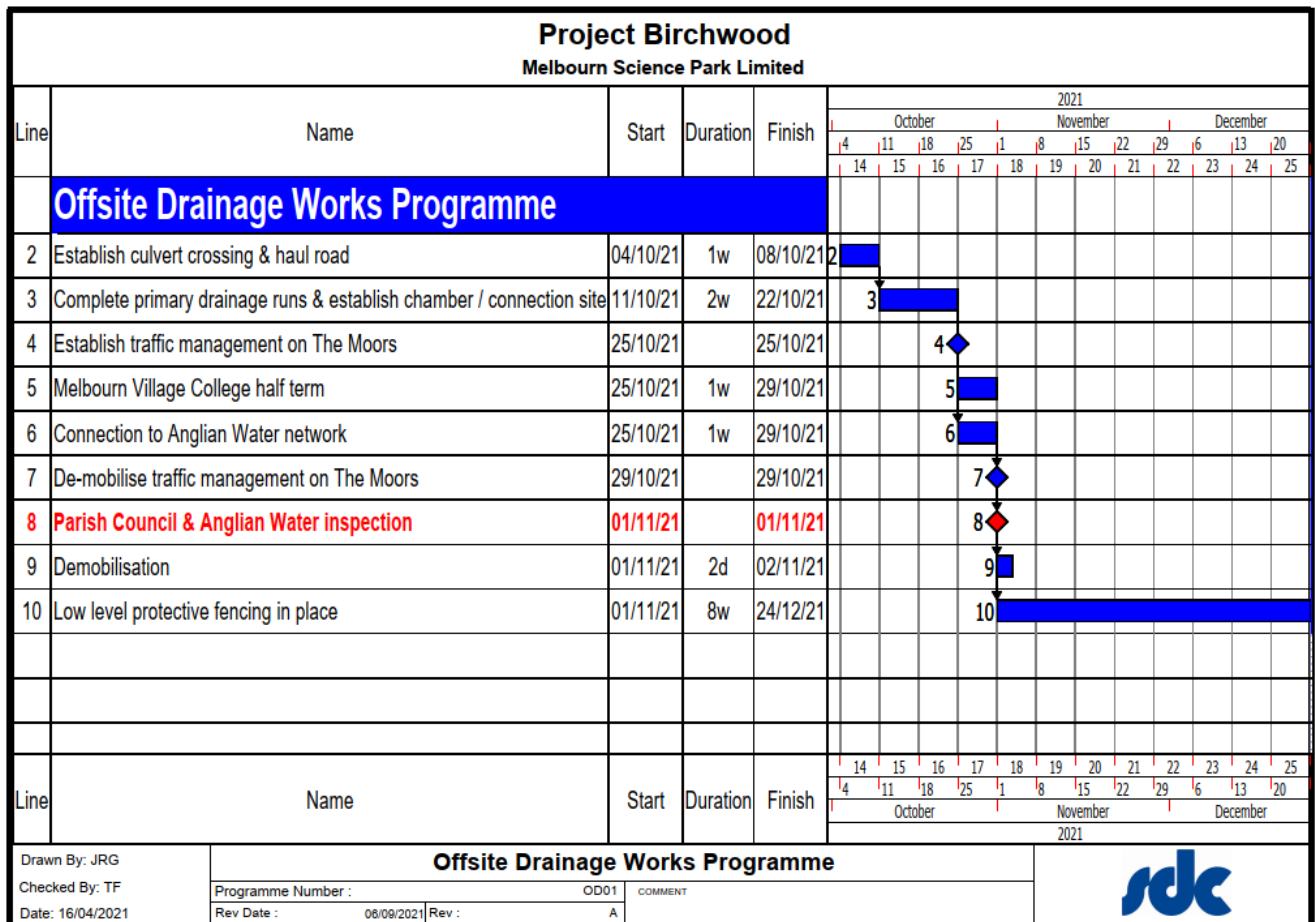

Method Statement Written By: Tom Fenner

Date: 20th September 2021

Issued For: Use

****End of Document****

Notes

The purpose of this drawing is to indicate the 6m easement required by the Parish Council only.

For construction plans and details refer to the following drawings:
 BWD-SWH-ZZ-ZZ-DR-C-0531 (plan and Anglian Water connection)
 BWD-SWH-ZZ-ZZ-DR-C-0550 to 0556 (details)

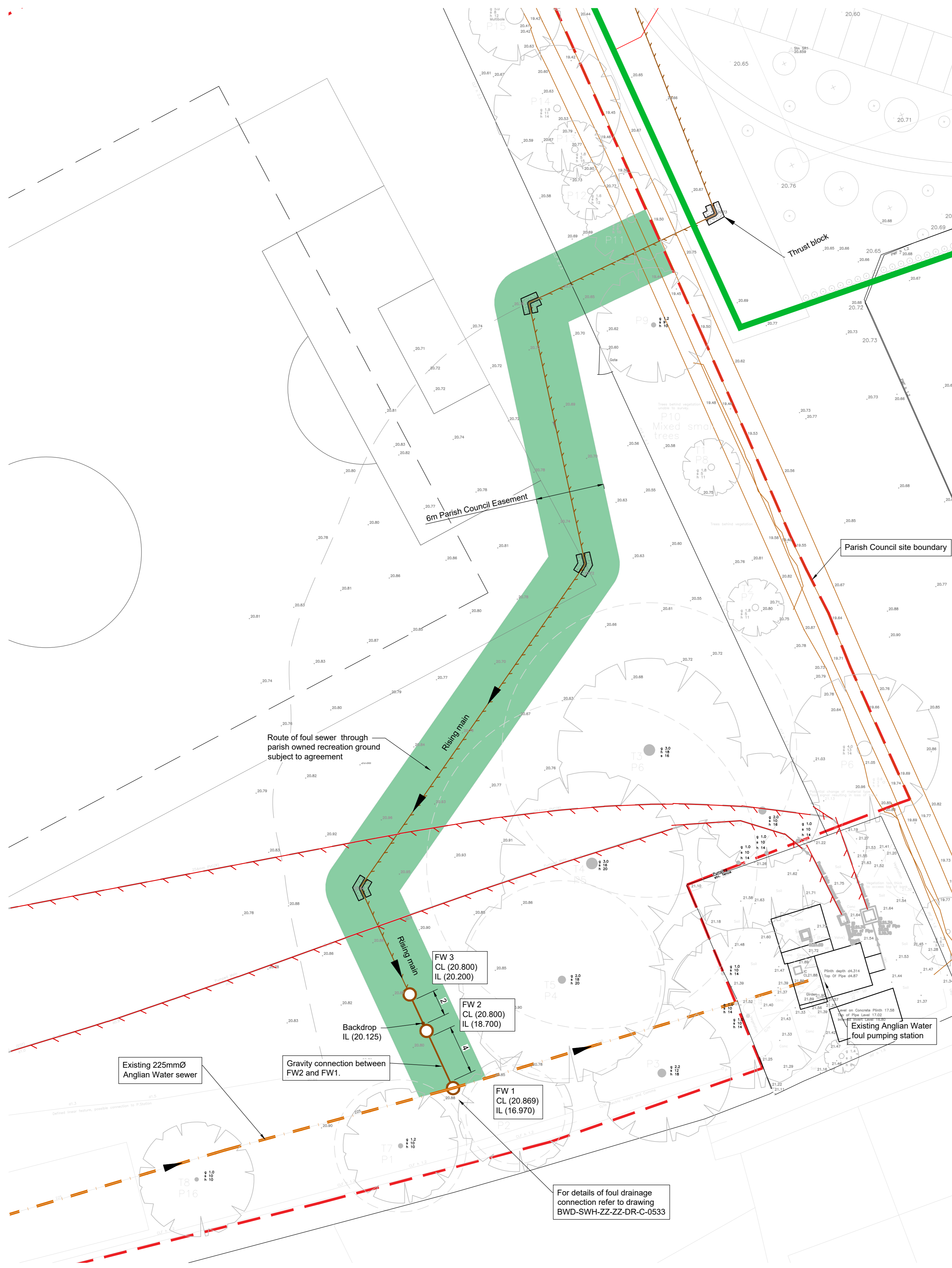

DO NOT SCALE FROM THIS DRAWING

HAZARDS LEADING TO UNUSUAL OR SIGNIFICANT RISKS DURING THE CONSTRUCTION PROCESS ARE IDENTIFIED ON THIS DRAWING AS:

NOTE: THE LIST BELOW IDENTIFIES CERTAIN RISKS WHICH ARE DEEMED TO BE UNUSUAL, ABNORMAL OR UNEXPECTED TO A COMPETENT CONTRACTOR CARRYING OUT WORK OF THIS NATURE BUT DOES NOT COVER ALL POSSIBLE SITUATIONS WHICH MAY BE ENCOUNTERED DURING THE CONSTRUCTION PROCESS. IT IS THEREFORE THE MAIN CONTRACTOR'S RESPONSIBILITY TO IDENTIFY ANY FURTHER RISKS/HAZARDS AND TAKE APPROPRIATE ACTION.

RISKS/HAZARDS SPECIFIC TO THIS DRAWING:

FOR TENDER - NOT FOR CONSTRUCTION

Rev.	Amendment	NSC	DA	DA	20.07.21
T01	TENDER ISSUE				
		Dm.	Chkd.	Appd.	Date

**BIRCHWOOD FIELDS
MELBOURN FARM**

Drawing
**OFF-SITE DRAINAGE SCHEME
PARISH COUNCIL EASEMENT**

Client
 SDC

Scott White and Hookins
 Structural Engineering | Civil Engineering | Sustainability and BREEAM | CDM Consultancy

Fountain House, 26 St John's Street, Bedford MK42 0AQ
 T: +44 (0)1234 213111 W: www.swh.co.uk E: info@swh.co.uk

Scale at A1 - 1:200 U.N.O

BWD-SWH-ZZ-XX-DR-D-0533-T01

Project | Originator | Zone | Level | Type | Role | Number | Rev.



HM Land Registry

BETA

MapSearch Snapshot

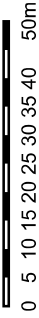
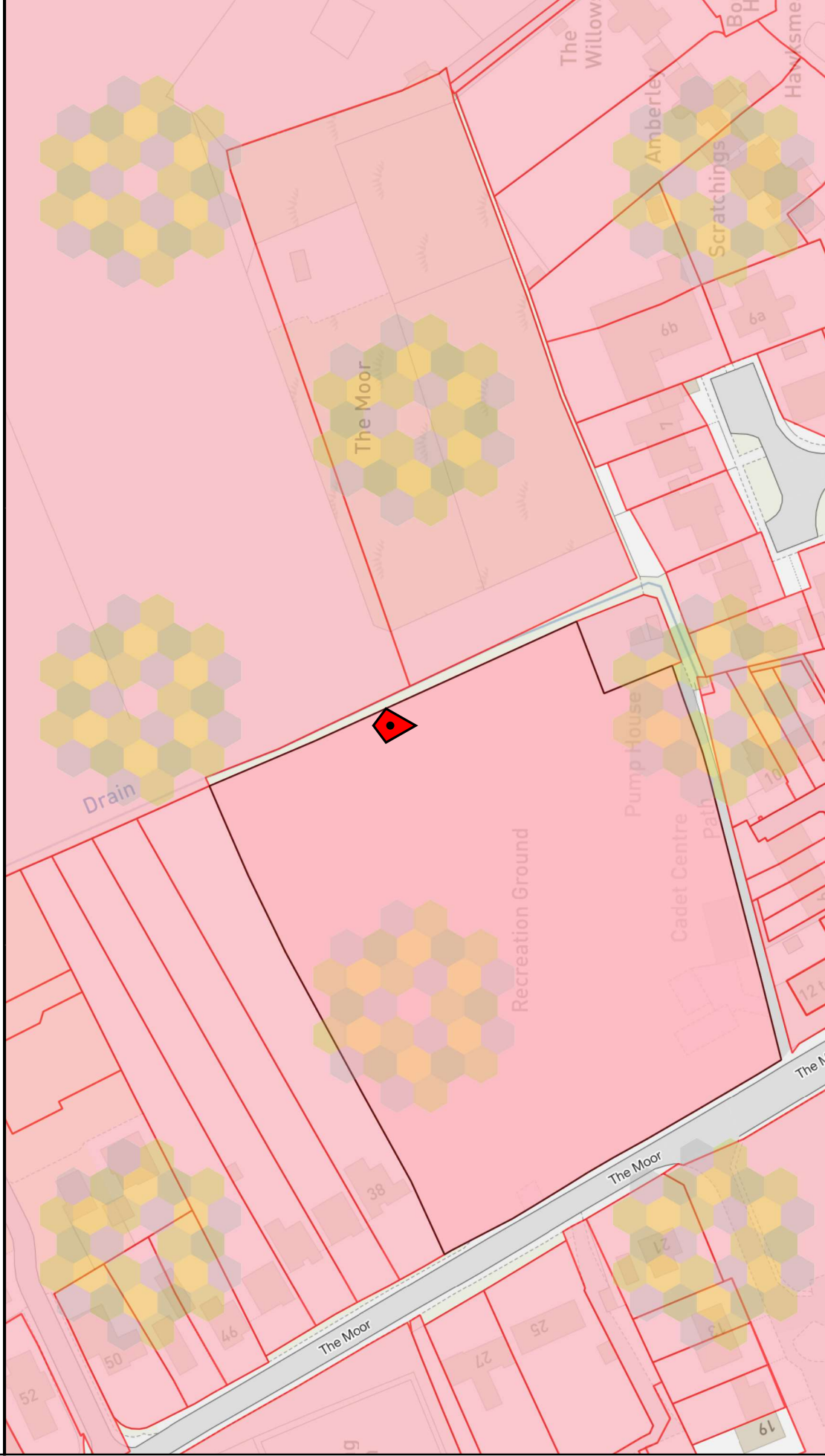

Map scale 1:1250

© Crown copyright and database rights 2021 Ordnance Survey 100026316
 This map is for reference purposes only. You are not permitted to copy, sub-license, distribute or sell any of this data to third parties in any form.
 Data last updated 10:00pm 31 AUGUST, 2021

**Darren Harward
Painter and Decorator
19 Masefield Way
Royston
Herts
SG8 5UU**

10th August 2021

Melbourn Parish Council
High Street
Melbourn
Herts

For the Attention of: Claire Littlewood

ESTIMATE

Re: Exterior painting works to the Sports Pavilion,
Melbourn Recreational Ground

Soffits and Fascia Boards

- Rub down all woodwork and fill where necessary.

- Repaint using Dulux Weathershield (colour to be decided.)

Back Wall

- Repair and fill cracks where necessary.
- Apply 3 coats of Dulux Weathershield masonry paint in white.

Front Wall (Green)

- Repair and fill cracks where necessary.
- Apply 3 coats of Dulux Weathershield masonry paint (colour to be decided.)

Railings

- Rub down all railings.
- Apply 2 coats of Hammerite metal undercoat.
- Apply 2 coats of Hammerite metal gloss in white.

Total price (including labour and materials) £2200.00
(£1400.00 without the railings)

Darren Harward

Unit 20 South Cambridge Business Park,
Sawston, Cambridge CB22 3JH
Telephone: 01223 833426 Fax: 01223 835097
sales@shelfordheating.co.uk
www.shelfordheating.co.uk



More than just a service

heating plumbing renewables electrical

MELBOURN PARISH COUNCIL
THE PAVILLON
THE MOOR
MELBOURN
HERTFORDSHIRE
SG8-6ED

11/08/2021

Account No.: 32603

Quotation No.: Q03423 - Small Works

Quote Type: SMALL WORKS (ESTIMATED)

Property: THE PAVILLON, THE MOOR, MELBOURN, HERTFORDSHIRE, SG8-6ED

Dear Sir/Madam

Following our recent visit, we would like to advise you of the potential costs associated with the remedial works that are required and as detailed on our Engineers visit. We highlight below the intended works which we trust has been interpreted correctly. If you require further clarity or advice please do not hesitate to call us on 01223 833426 or email your query to sales@shelfordheating.co.uk and we will do all that we can to assist you further.

The Budget cost as follows will be fully calculated by the time expended on site by our Representatives and the Associated Parts purchased or utilised from our Stock holding which may decrease as we generally are cautious in presentation of our time and material allowances, however it can also have the negative effect especially if a situation arises that was not evident at the initial survey stage.

On completion you will be requested to confirm the time taken whilst on the job, and also for the materials used, this report will be forwarded with the invoice. In some circumstances additional time may need to be added to the physical time on the job to reflect returning and disposing of waste contaminants – an example of this would be the transfer of waste oil to a holding container for collection by our contractors.

Summary of Quoted Works:

- **Summary Introduction, Important Information, Site Set Up, Supervision & Waste including Approved Sub Contractors**
- We have included within our costs to undertake elements as described below in relation to the site set up, supervision and management, waste removal, disconnection and removal of redundant plant and equipment. Specialist plant such as scaffold systems, access platforms, and Hiab cranes are excluded unless detailed below. In certain circumstances due to time restraint's in preparing our costs we may include budget costs which will be highlighted as a Provisional Sum and as such may increase or decrease subject to the charges being applied by our contractors.
- To transport from site all waste, and return to our yard skip for safe disposal due to site restriction and skip location availability.
- To carry out protection of site/furniture/carpets ensuring plastic protectors is used and dust sheets where needed.

Unit 20 South Cambridge Business Park,
Sawston, Cambridge CB22 3JH
Telephone: 01223 833426 Fax: 01223 835097
sales@shelfordheating.co.uk
www.shelfordheating.co.uk



More than just a service

heating plumbing renewables electrical

- To carry our daily site supervision tasks associated with works including liaison with clients.
- **Copper pipe Services & Associated Fittings**
- To Supply and Install 15mm Copper pipe for Plumbing Services and Adjusting Cold fill to Urinals.
- **System Chemicals, Cleansing, & Care of water**
- To Supply and Install 3no. Cisterniser Infrared Flush Control Valves Mains or Battery Operated.
- To Strip and Clean the 5no. TMV, adjust and set temperatures. Unfortunately we will be unable to disinfect HWSV.
- **Pipe Insulation & Clips**
- To Inspect Loft Space Pipework Insulation.
- To Supply and Install Insulation to Pipework Within Boxing in Disabled WC. 15mm X 9mm X 2000MM.

The BUDGET cost of the installation as per our schedule is **£1,429.70** (Excluding VAT) and including all parts and labour.

VAT is calculated at 20% and this amount is **£285.94**

The Total Works including VAT is **£1,715.64**

We very much hope that you will wish to proceed with the proposed alterations and, if should you wish to proceed, simply refer to the information provided on the accompanying form entitled 'Payment Options and Acceptance Details' which is at the end of this letter.

Please also see below some important additional information relating to this Budget Costing.

If you would like any further information or assistance, please contact us and we will assist your enquiry.

Yours sincerely

Sam Wilson - Installation & Technical Manager
sam.wilson@shelfordheating.co.uk

Unit 20 South Cambridge Business Park,
Sawston, Cambridge CB22 3JH
Telephone: 01223 833426 Fax: 01223 835097
sales@shelfordheating.co.uk
www.shelfordheating.co.uk



More than just a service

heating plumbing renewables electrical

Our Standard Terms of Contract

- Our Full Terms and Conditions are available on request, or alternatively on our web site which can be viewed at shelfordheating.co.uk
- The components we install are fully guaranteed for a Minimum 12 months from installation.
- Failure of components within warranty as a result of issues associated with Water Contamination/Sign of Damage after installation is not covered. All faulty goods are returned to our suppliers for confirmation.
- We remove all existing redundant waste materials from site and dispose using registered waste carrier, in the case of waste Fuel/ Contaminated Fuel/ Fuel Hoses and Filters these are disposed environmentally. Electrical components and faulty parts outside of warranty are not removed from site, this can be undertaken following a successful 14-day period of fault free operation.
- If any asbestos product is found either before or during the installation works, we will advise you of such, but as we are not licensed to remove this product we will not be held responsible for the removal or associated costs.
- We Supply and Install appropriate copper pipe-work (or similar) and solder type fittings including all necessary adaptations when Installing Heating, Plumbing and Gas Services.
- In difficult access areas and roof voids we will only use pipe and fittings which negate the need for naked flame and heat, subject to Risk assessment completed during the work.
- We endeavour to include for all works envisaged, however there are times when unforeseen items need rectifying to ensure compliance and were not evident at survey stage. We therefore reserve the right to charge accordingly any additional works.
- Please note that we cannot be held responsible for existing radiators; controls; hot water cylinders/tanks that we have not taken to replace within the scope of works. Any works necessary will be charged in addition to the contract.
- Our costs are based upon today's date, Parts are continually changing on a daily basis, and as such it is very difficult to fix our costs for small works issues, if the works are completed we will charge based on Materials and Labour expended on that visit.
- Our Quotations are Inclusive of VAT @ 20% for works at standard VAT, all works relating to renewable energy will be VAT rated at 5%. (HMRC rules will always be applied)
- You Must Notify us in writing of any concerns associated with our Work or Billing within 14-days,
- We reserve the right to charge for late payments as per our Full Terms and Conditions of Sale.
- All Powerflushing works will require a disclaimer document to be completed.
- By agreeing to this contract, you have read and understood our terms and conditions of Business which are available online on our web site, or that can be issued by letter.
- By agreeing to this contract, you have read and understood our terms and conditions of Business which are available online on our web site, or that can be issued by letter.
- **The above does not affect your statutory rights.**

Unit 20 South Cambridge Business Park,
Sawston, Cambridge CB22 3JH
Telephone: 01223 833426 Fax: 01223 835097
sales@shelfordheating.co.uk
www.shelfordheating.co.uk



More than just a service

heating plumbing renewables electrical

Payment Options and Acceptance Details

On receipt of your completed acceptance (and deposit if stated below), we will assign an installation team/service technician to carry out your alterations and then contact you with a date of commencement. If necessary, we may also arrange an interim visit to confirm our work schedule.

Deposits are taken generally when special items are ordered that entail restocking charges if the works are to be cancelled by you or when the value of the programmed works exceed £1000.00.

Your deposit may be paid by cheque and returned to us with your acceptance slip, or you may prefer to telephone us and make your deposit payment using your debit card

Payment of the balance can then be made either by cheque/debit card/or direct to our Bank Account within 14 days.

For your Information the Breakdown between Materials and Labour is as Follows

Materials = £639.82 Plus Vat
Labour = £789.88 Plus Vat

25% Deposit If Applicable	£428.91
Balance payable within 14 days of invoice	£1,286.73
Total payable	£1,715.64

Check list

Complete the acceptance slip
Enclose the deposit payment made payable to **Shelford Heating Ltd** or Transfer Payment by direct Bank Transfer to Account No.: 26654060 Sort Code: 30-64-79
Or telephone 01223 833426 with your Debit card details, Quotation number and Customer account number. The Maximum value taken on any payment for a single invoice is £250.00 which has been limited due to the high charges associated with credit card payments.

Unit 20 South Cambridge Business Park,
Sawston, Cambridge CB22 3JH
Telephone: 01223 833426 Fax: 01223 835097
sales@shelfordheating.co.uk
www.shelfordheating.co.uk



More than just a service

heating plumbing renewables electrical

Acceptance

Account No.: 32603

Quotation No.: Q03423 - Small Works

Property: THE PAVILLON, THE MOOR, MELBOURN, HERTFORDSHIRE, SG8-6ED

MELBOURN PARISH COUNCIL
THE PAVILLON
THE MOOR
MELBOURN
HERTFORDSHIRE
SG8-6ED

Deposit of £428.91

Cheque

Debit/Credit Card

Bank Transfer

- I enclose my Cheque Payment
- I will contact you to make payment by Card
- I have transferred Payment Direct to your Bank Account

Sign..... Date:.....

Shelford – quotation breakdown

Jobs have been identified at the pavilion and Shelford Heating have quoted for these.

Thank you for your email.

The costs we have provided are budget costs, and therefore you will be charged for the materials used and time spent on site. We have it noted in our quotation that:

The Budget cost as follows will be fully calculated by the time expended on site by our Representatives and the Associated Parts purchased or utilised from our Stock holding which may decrease as we generally are cautious in presentation of our time and material allowances, however it can also have the negative effect especially if a situation arises that was not evident at the initial survey stage.

However, please see below the costs we have allowed:

- 1. To Supply and Install 15mm copper pipe for Plumbing Services and Adjusting Cold fill to Urinal*
We have allowed £56.03 + VAT to supply and fit the above
- 2. To Supply and Install 3no. Cisterniser Infrared Flush Control Valves Mains or Battery Operated.*
We have allowed £657.20 + VAT to supply and fit the above.
- 3. To Strip and Clean the 5no. TMV, adjust and set temperatures. Unfortunately we will be unable to disinfect HWSV.*
We have allowed labour only at a cost of £367.50 + VAT.
- 4. To Inspect Loft Space Pipework Insulation.*
We have allowed labour only at a cost of £98.00 + VAT.
- 5. To Supply and Install Insulation to Pipework Within Boxing in Disabled WC. 15mm X 9mm X 2000MM.*
We have allowed £52.73 + VAT to supply and fit the above.

If you have any questions or queries, please do not hesitate to contact us via email or on 01223 833426.

Kind regards

*Amy Wilson
Installation Coordinator*

Job 1) Urinals ...

Shelford – quotation breakdown

Job 2) The legionella risk assessment recommended fitting automatic flushing or flushing through manually manual flushing through is taking place so the installation of automatic flushing valves is not needed.

Job 3) The legionella risk assessment recommended that all TMV's should be serviced annually.

Jobs 4&5) The legionella risk assessment recommended installing insulation to pipework as a high priority job.

Melbourn Timebank Report – August 2021



Membership growth to 19 August 2021

	As at 19 July	As at 19 August	Conversion	Pipeline
Individual Members	80	80	0	2
Organisational Members	13	14	1	1

Total exchanges to date: 3346 hours (of which MCCR = 1680.5 hours)

Non MCCR: 1665.5 hours

Timebank activities



Memory Café

Solo Sunday lunch

Coffee morning

1:1 exchange

- 22 July Meeting with **Cam Sight** to explore support of monthly group meetings
- 24 July Memory Café, Bingo with afternoon tea in support of Community Support for Dementia
- 27 July **Cam Sight joined as an organisation member**
- 2 Aug Games night at the Black Horse
- 7 Aug Memory Café at Elysium
- 8 Aug Solo Sunday Lunch at The Chequers, Fowlmere
- 9 Aug Meeting with Sawston coordinator to share information and initiatives
- 14 Aug Garden Party at Margaret House for CS4D members
- 18 Aug #Wednesday Walk' coordinator attended
- Coffee morning – every Thursday 10-12 currently at the Hub
- **5 Members signed up to Tempo Time Credits**
- **Covid Enabler grant of £500 awarded for purchase of a gazebo**
- **Successful connections and support with Social Prescriber link workers**
- Knitting of 'Fidget Mats' ongoing, 5 scarves for Christmas boxes for homeless, hats for premature babies on hold at the moment as no more required at present
- 1:1 exchanges, litter picking and remote support by Coordinator to combat loneliness - ongoing

Forthcoming Events and Administrative tasks:

- 23 Aug Games night
- 12 Sept Solo lunch
- Dog Café, Arts & Craft Group and Quiz nights TBC
- Facebook statistics for last 28 days
 - Followers 333
 - Maximum post reach 1063
 - Post engagement 57

Proposed expenditure for approval

- None

Melbourn Timebank Report – September 2021



Membership growth to 19 September 2021

	As at 19 August	As at 19 September	Conversion	Pipeline
Individual Members	80	81	1	2
Organisational Members	14	16	2	1

Total exchanges to date: 3531 hours (of which MCCR = 1680.5 hours)

Non MCCR: 1850.5 hours

Timebank activities



Solo Sunday lunch

Madingly Hall

- 16 Aug Coombes Centre visit
- 26 Aug **Cam Sight** attended Coffee morning
- 4 Sep Support of Home–Start at Buntingford car show
- 8 Sep Madingly Hall walk and tea
- 14 Sep **The Dolphin join as an Organisation member**
- 15 Sep #Wednesday Health walk
- 16 Sep **1st Rainbows join as an Organisation member**
- 18 Sep **CS4D** afternoon tea with singer Tom at Meldreth Village Hall supported by Timebank members
- 19 Sep **Solo Sunday Lunch** at The Chequers, Fowlmere
- 20 Sep **Games night** at The Black Horse
- 21 Sep Meeting with Sawston coordinator to share information and initiatives
- 22 Sep **Arts & Crafts** group at The Dolphin reintroduced
- 28 Sep **Dog Café** introduced at The Dolphin
- **Coffee morning Thursdays 10-12 now at The Dolphin**
- Successful connections and support with Social Prescriber link workers ongoing
- Knitting of 'Fidget Mats' ongoing, 7 scarves for Christmas boxes for homeless
- 1:1 exchanges, help with errands and reintegration into community of isolated members

Forthcoming Events and Administrative tasks:

- Quiz nights to explored
- Book Club to be introduced
- Facebook statistics for last 28 days
 - Followers 343
 - Post engagement 64

Proposed expenditure for approval

- None

Modern Slavery Statement

Introduction

This Statement sets out what steps Melbourn Parish Council has taken and what steps it will take in future to ensure that it will never knowingly allow modern slavery or human trafficking in any part of the Council's business.

What is Modern Slavery?

Modern slavery encompasses slavery, servitude, forced and compulsory labour, and human trafficking. Traffickers and slave drivers coerce, deceive and force individuals against their will into a life of abuse, servitude and inhumane treatment (HM Government Modern Slavery Strategy, 2014).

According to the Local Government Association (LGA), the term 'Modern Slavery' includes a range of different types of exploitations, that may or may not occur together. The different types of exploitations include but are not limited to:

- sexual exploitation
- domestic servitude
- forced labour
- child exploitation
- criminal exploitation
- other forms of exploitation, such as: organ removal; forced begging; forced benefit fraud; forced marriage and illegal adoption

The Role of Local Authorities

Within their [Tackling Modern Slavery: A Council Guide \(2017\)](#) document, the LGA highlight the following roles of local authorities in tackling modern slavery:

1. Identification and referral of victims
2. Supporting victims – this can be through safeguarding children and adults with care and support needs and through housing/homelessness services
3. Community safety services and disruption activities
4. Making best that the supply chains councils procure from are free from modern slavery.

Existing Policies and Procedures

Melbourn Parish Council has a range of policies, processes, procedures and practices which help to ensure that we are acting ethically and with integrity to prevent slavery and human trafficking, including the following:

- **Safeguarding Policy**
- **Whistleblowing Policy**
- **Employment Policy**
- **Equality and Diversity Policy**
- **Recruitment Process**
- **Code of Conduct**
- **Appointment of Contractors and Procurement Policy and Procedure**

Due Diligence Processes

- **Procurement**
- Melbourn Parish Council will, through its procurement procedures, use its best endeavours to ensure that suppliers of goods and services share its commitment to prevent modern slavery.

- **Safeguarding Training:** This includes how to spot the signs of modern slavery and how to make a referral. Melbourn Parish Council's Safeguarding Officer has undergone safeguarding training. Claire Littlewood is the Safeguarding Officer – parishclerk@melbournpc.co.uk.

- **Reporting for Council employees:** Any Melbourn Parish Council employee affected by modern slavery, or who suspect someone may be at risk are advised to contact the Safeguarding Officer - parishclerk@melbournpc.co.uk.

- **Reporting for residents and communities:** The advice to anyone affected by slavery, or who may suspect someone is at risk, is to:
 - Call 999 if it is an emergency
 - Call 101 for non-emergencies
 - Call Crimestoppers anonymously on 0800 555 111
 - Call the Modern Slavery Helpline on 08000 121 700
 - Report online via the [Modern Slavery Helpline](#)

Document Approval:



(Chair to Melbourn Parish Council)

Date of Parish Council meeting : 27 September 2021

Review every 12 months

**Melbourn Parish Council
Financial Risk Register 2021-22**

**Doc. No. 4.20
Review date: September 2022**

Risk No.	Description (the risk is that...)	Impact (the impact on MPC would be...)	Likelihood Score (1-3)	Impact Score (1-3)	Risk Rating (High, Medium, Low)	Response (what actions have been taken/are in progress)
F1	Expenditure is incurred or grants awarded without proper legal authority	Potential for complaints, fines, qualified audit report	1	2	Low (2)	Qualified staff. Record of power under which grants are awarded is minuted.
F2	The PC has insufficient General Reserves so is at risk of bankruptcy if precept is not paid on time	Inability to provide services or pay staff salaries and other contractual liabilities	1	3	Medium (3)	MPC holds 6 months of running costs in general reserve in line with its Reserves Policy.
F3	An adequate record of the Council's assets is not maintained	Potential theft or misappropriation of assets Assets could fall into disrepair. Assets may be inadequately insured	1	3	Medium (3)	Asset register in place and reviewed annually. New acquisitions and disposals recorded. Periodic inventory checks carried out. Insurance cover linked to asset register. Professional insurance valuation of buildings undertaken and to be done every 5 years.
F4	The PC has insufficient money ring-fenced in Asset Replacement/Maintenance Reserves The PC does not have a maintenance plan so the budget for maintenance will be insufficient	Assets could fall into disrepair. Potential H&S concerns as well as adverse service delivery and rental income impact.	2	3	High (6)	Full asset register in place. Ongoing maintenance spend requirements included in precept. MPC building up Asset Management Reserve and linking it to asset renewal programme(Action). Maintenance Committee prioritise and monitor maintenance spend monthly.
F5	Cash is lost through theft/misappropriation	Funding shortfall Adverse publicity	1	1	Low (1)	Limited cash held and banked promptly. Controls over dealing with cash. Small

**Melbourn Parish Council
Financial Risk Register 2021-22**

**Doc. No. 4.20
Review date: September 2022**

						petty cash float. Petty cash procedure. Fidelity Guarantee (insurance).
F6	Failure to ensure proper use of funds under S137	Total S137 expenditure could exceed statutory limit for MPC	1	1	Low (1)	Qualified Clerk. Powers for grant approvals minuted.
F7	Proper financial records are not kept	Inadequate understanding of financial position of the authority. Potential qualified audit.	1	3	Medium (3)	RFO in place. Regular finance reports submitted at meetings. Two internal audit visits per year.
F8	Poor Financial Management	MPC could run out of funds before the financial year end. Risk to service delivery.	1	3	Medium (3)	RFO in place. Regular budget progress reports/monitoring. Reserves of over 5 mths running costs.
F9	Failure to set a precept within sound budgeting arrangements.	Inadequate funds to effectively carry out planned services. Unjustified precept charge to parishioners.	1	3	Medium (3)	RFO in place. Rigorous precept setting process followed. Adequacy of reserves considered when setting precept. Regular budget monitoring throughout the year.
F11	Failure to maintain an effective bank payments system	Loss of funds from bank due to staff error or fraud.	1	2	Low (2)	Controls in place over bank payments – proper separation of duties. All payments approved by council and minuted. Review of bank reconciliations by PC member. Regular budget monitoring. Fidelity Guarantee (insurance)
F12	Loss of funds due to bank failure	Any funds above FSCS guarantee limit could be lost. Impact on ability to deliver services and projects and meet contractual payments.	1	3	Medium (3)	Guarantee limit of £85k per financial institution. Investment policy in place. Spread of investments among different institutions.
F13	Failure to collect income from customers	Funding shortfall which needs to be met from elsewhere.	1	1	Low (1)	Responsibility for collection of debts defined – separation of duties. Budget monitoring. Procedures to chase outstanding debts.

**Melbourn Parish Council
Financial Risk Register 2021-22**

**Doc. No. 4.20
Review date: September 2022**

	Loss of tenant for Little Hands Nursery building	Funding shortfall which needs to be met from elsewhere.	1	3	Medium (3)	Longstanding tenant. Reserves of 6 months to cover income shortfall.
F14	Claims will be made on insurance due to accidents in, on or around Council property (includes maintenance of public open spaces)	Adverse publicity Failure in duty of care to parishioners Increased insurance premiums	2	2	Medium (4)	Wardens regularly inspect and mend things. Cllr inspections. Maintenance Committee oversees and monitors. Process over awarding of major Maintenance Contracts. Risk assessments carried out. Public Liability Insurance held.
F15	New employees in key officer roles	Loss of funds through staff error or fraud	1	2	Low (2)	Staff continuity in key officer roles. Recruitment processes and references. Separation of staff duties/RFO separate from Clerk. Internal controls in place over bank payments and cash handling. Staff training and performance reviews. Fidelity guarantee (insurance)
F16	Melbourn Community Hub Management Committee might not be able to make the Hub financially viable.	The Hub might need to be managed and run by MPC. Potential adverse impact on reserves and increase in precept	1	3	Medium (3)	MPC works closely with the Hub Management Group and several Cllrs are directors. Regular finance reports provided to MPC. Financial assistance via grant given by MPC.
F17	SCDC and CCC are unable to perform their delegated tasks and these get pushed down to Parish Council level	The Precept would need to be increased to enable MPC to carry out additional duties	2	3	High (6)	MPC works closely with its District and County Cllrs and should get warning of any proposed changes so that it can make appropriate plans. MPC must continue to do this (Action).
F18	Damage or loss by fire, weather or vandalism of Councils assets	Potential adverse service disruption and unbudgeted outlay for replacements/repairs	2	2	Medium (4)	Asset register is linked to MPC's insurance policy. Wardens and regular Maintenance Contractors report damage to assets. Asset inspections

**Melbourn Parish Council
Financial Risk Register 2021-22**

**Doc. No. 4.20
Review date: September 2022**

						programme. Risk assessments and fire prevention measures in place.
F19	Lack of financial controls when appointing contractors and lack of monitoring of contractors following appointment	MPC may not get the best value from its contractors and may not get the service that it has paid for. Contractors may go out of business with an adverse impact on services.	2	2	Medium (4)	Policy for appointment & management of contractors. Policy includes financial checks. The Financial Regulations have controls around tender procedures and quotes. Maintenance Committee/Clerk monitors contractor performance.
F20	Inadequate financial controls around ordering goods and services	The Council may not get best value for goods and services and may commit to expenditure without the necessary budget being available	1	3	Medium (3)	Financial Regulations/Standing Orders detail procedures for authorisation of orders. It is potentially a disciplinary offence not to follow Financial Regulations. Extra checks on approvals for ordering introduced. MPC policy for awarding contracts.
F21	Loss of Financial Records.	Inability to access financial information. Failure to meet statutory requirements regarding record keeping.	1	3	Medium (3)	Financial accounting system is on a cloud-based system that is backed up remotely. Computerised finance records are regularly backed up.
F22	Investments made by MPC lose money	The council would have to make the shortfall up from elsewhere	1	3	Medium (3)	Investment strategy in place – low risk investments made and reviewed annually.
F23	Covid-19 pandemic may have an unforeseen impact on MPC finances	Additional unbudgeted costs may fall on the parish council which could impact planned service delivery and projects.	2	2	Medium (4)	Position kept under review. Reserves in place of 6 months. It may be possible to move funds from other ring-fenced reserves in an emergency.
F24	Inadequate controls over salaries and associated costs	Salaries paid incorrectly or fraudulently. Incorrect deductions made and potential fines by HMRC	1	2	Low (2)	HR Panel approve salary budget. Amendments to pay rates/hours are approved by HR/MPC. Signatories check salary amounts paid. Budget monitoring.

**Melbourn Parish Council
Financial Risk Register 2021-22**

**Doc. No. 4.20
Review date: September 2022**

						Payroll software package used for deductions and returns to HMRC.
--	--	--	--	--	--	---

Likelihood Scores	Impact Scores	Risk Rating Scores (Likelihood x Impact)
Low (unlikely) = 1 Medium (possible) = 2 High (highly likely) = 3	Low (negligible) = 1 Medium (moderate) = 2 High (Severe) = 3	Low = 1,2 Medium = 3, 4 High = 6,9



Document Approval:

(Chair to Melbourn Parish Council)

Date of Parish Council meeting: 27 September 2021

Review Policy: Every 12 months

COVID 19: Please note the following additional precautions which must be taken during the current pandemic.

- **Risk of infection** : Service Provider must ensure that they adhered to current guidelines with regard to social distancing and face coverings. The most up to date source for guidance is the Gov.uk website.
- **Equipment** : Equipment provided is for the sole use of the Service Provider.
- **Gloves** : Service Provider **must** wear the gloves provided when litter picking. This protects against injury but also from risk of infection.
- Service Provider must use the litter picking equipment when picking up masks, gloves or other items which may carry the Covid virus. **Caution must be used at all times to ensure that Service Provider do not put themselves at risk of infection through contact with discarded masks or other PPE**

Litter Picking in Melbourn - Risk Assessment (Parish Council Staff and Service Providers)

RISK ASSESSMENT MATRIX

Risk = Hazard Severity(A) x Likelihood of occurrence(B) (Probability)

(A) Hazard Severity Should be assessed on a scale of 1 - 5:

1. Low (minor injury to one individual)
2. Slight (injury or disease capable of keeping one person off work 3 or more days)
3. Moderate (injury or disease capable of keeping more than one person off work for 3 or more days)
4. High (death to an individual)
5. Very High (multiple deaths)

(B) Likelihood of occurrence (probability) Should be assessed on a scale of 1- 5:

1. Not likely (an injury may occur less than once in a working year, doing this activity every day)
2. Possible (an injury may occur once in a working year, doing this activity every day)
3. Occasional (an injury is likely to occur 2 or 3 times in a working year, doing this activity every day)
4. Common (an injury is likely to occur more than 3 times in a working year, doing this activity every day)
5. Likely (an injury is probably going to occur)

Use the Risk Equation above to determine the level of **Risk**. This ranges from 1 (low severity and unlikely), to 25, (just

waiting to happen with widespread and dangerous results). Use the equation above to determine a **risk factor** ranging from 1 (no severity and unlikely to happen) to 25 (just waiting to happen, with disastrous and widespread results). To make equation work effectively, 'likelihood' and 'severity' must be judged independently.

Judgement of Risk Factors

1-3 Low, improve when possible; 4-9 Medium risk factor, improve as soon as possible; 10+ Deal with the risk before you start the task, preferably before anyone else arrives on site. A risk factor of 10+ is unacceptable. If it cannot be reduced, do not carry out the task.

NB – the matrix does not need to be completed afresh for each event, as the task profiles are similar for every worker or work party

Activity: Litter Picking by Parish Council Staff and/or Service Provider Site location: Melbourn Village					Name of assessor: John Travis Date of assessment:
Description of hazard	Severity of hazard (A), score 1 – 5	Probability of harm (B), score 1 – 5	Risk factor (A x B)	Action required	Notes
Use of eBike and trailer – injury associated with using the eBike on the highway (other traffic) or falling from the bike	3	1	3	Ensure Service Provider is competent, willing and able to use the eBike. Service Provider to be responsible for using protective equipment (helmet) at all times when using the eBike. Ensure the bike is in good order and condition. PC to be responsible for rectifying any defects immediately. Ensure Service Provider wears hi-viz when using the eBike on the highway.	<p>If the Service Provider reports any defects with the eBike, the Parish Council will rectify such defects at its expense. The eBike will NOT be used until any defects have been rectified.</p> <p>The Service Provider is responsible for ensuring that they have appropriate safety equipment, to include a helmet and hi-viz, which must be used at all times.</p> <p>The Service Provider will confirm that they are capable and willing to use the eBike. If they do not feel comfortable using the equipment, they must notify the parish office without delay.</p> <p>The Service Provider understands that they are responsible for safe and responsible use of the eBike and other equipment when working on behalf of the Parish Council.</p>

Contamination/back strain from collecting general litter (paper/plastic/unbroken glass/cardboard etc.)	1	1	1	Ensure staff and/or Service Provider use hand-operated litter pick tools to collect general litter and use gloves	Avoid constant bending and possible back strain by using the litter pick tools. Equipment is available from the Parish Office.
Strain from carrying heavy bags of collected litter	1	1	1	Ensure bags are not overloaded and lift using legs not back. Village warden's van can be used for roadside collection. Alternatively, the Parish Office can request collection by SCDC refuse operatives.	Individuals to take care not to attempt to carry very heavy bags, for example to the Village Warden's vehicle
Impact from passing motor traffic and bicycles	4	1	4	High-visibility clothing must be worn when working at roadside locations. Hi viz vests are available from the Parish Office.	Make sure working locations have sufficient off-road working space for safe operation.
Tripping/twisting due to uneven ground	1	2	2	Be aware of potentially unseen obstacles and depressions in pavements and verges.	Staff and/or Service Provider to report significant obstacles and avoid especially difficult to access areas
Eye level twigs and branches	1	2	2	Staff and/or Service Provider to exercise caution when working near shrubs and trees.	
Sharp objects such as metal lids and glass	1	2	2	Exercise caution and avoid kneeling while working. Separate glass and metal from other litter and collect in buckets not black bags.	Use litter pick-up tools wherever possible
Needles and syringes	4	2	8	Exercise caution when picking up or touching needles or syringes. Gloves are available from the Parish Office.	Ensure that appropriate gloves are worn to prevent injury from sharps Ensure that sharps are appropriately disposed of (sharps box)
Unattended tools	1	2	2	Ensure that tools are not left unattended at any time	
Exposure to cold weather	2	2	4	Be aware of bad weather (cold, icy, wet conditions particularly)	Ensure appropriate clothing for the weather.
Weil's diseases	1	1	1	Advise all of symptoms of Weil's disease and action to be taken	Cover cuts with waterproof plasters Have clean water available for washing cuts Have clean water available for washing hands prior to eating or touching eyes

					Wet wipe tissues should also be available Advise Parish Clerk of concern of contamination
Disposal of collected litter and waste	2	1	2	Ensure consolidated litter is stacked safely and on a site with reasonable protection from children and public. Make prompt arrangements for central collection and disposal	Arrange with Parish Clerk for collection by SCDC or other appropriate authority
Contamination from dog fouling and subsequent problems such as eye damage	2	1	2	Exercise caution and avoid coming into contact with dog waste.	Ensure appropriate hand protection is worn

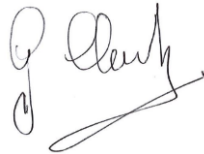

Document Approval:

(Chair to Melbourn Parish Council)

Date of Parish Council Meeting: 27 September 2021

Review every 12 months