

MELBOURN PARISH COUNCIL

Full Council Meeting : 25 October 2021

Item: PC094/21b) Request for provision of a skate park

Request from the public

I am contacting you to discuss the lack of any form of skatepark within our village. I have lived in the village the majority of my life and am a keen bmx rider. We used to have a small but very good mini ramp based at the Moor that I spent many hours using, however to my disappointment it was removed some years ago now and has never been replaced by a new one or better still an actual skatepark. As stated I am very much in to the sport however I must travel to other, in many cases much smaller villages that actually have skateparks to use one. I am now a father to 3 with 2 of my children showing a keen interest in bmx riding however it is difficult to get the whole family and bikes to another village to use a skatepark. I am very surprised/disappointed that villages not on the same scale, Haslingfield for instance, have these facilities however our village does not. The sports of bmx, skateboard and scooter riding are very in trend right now and encouragement for the youth of the village to get into them and be active rather than sitting on a screen I feel, would be welcome. Could you please advise if there are any plans for a skatepark in the near future and if not could you please consider this as a request to open a discussion for a skatepark to be built within the village.

Inside Quad with 12xLB1
RRP: €49'520
Length: 52.7m
Area: 78m2

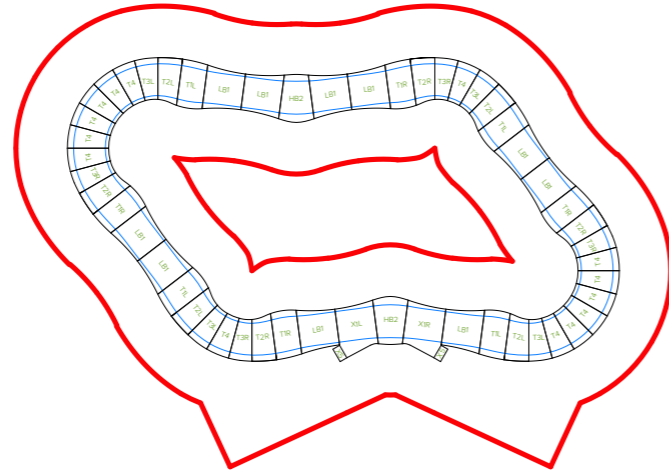

Straight Quad with 16xLB1
RRP: €53'020
Length: 59m
Area: 86.7m2

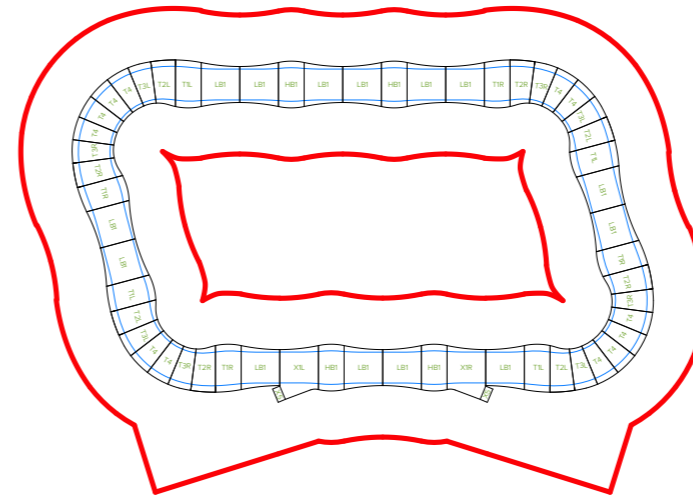

Inside Quad with 16xLB1
RRP: €57'220
Length: 62.6m
Area: 92.3m

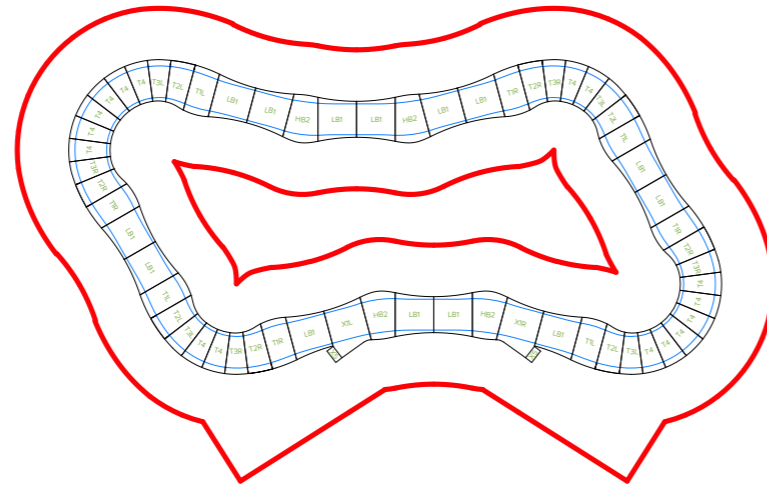

Combo Quad with 16xLB1
RRP: €55'120
Length: 60.8m
Area: 89.5m2

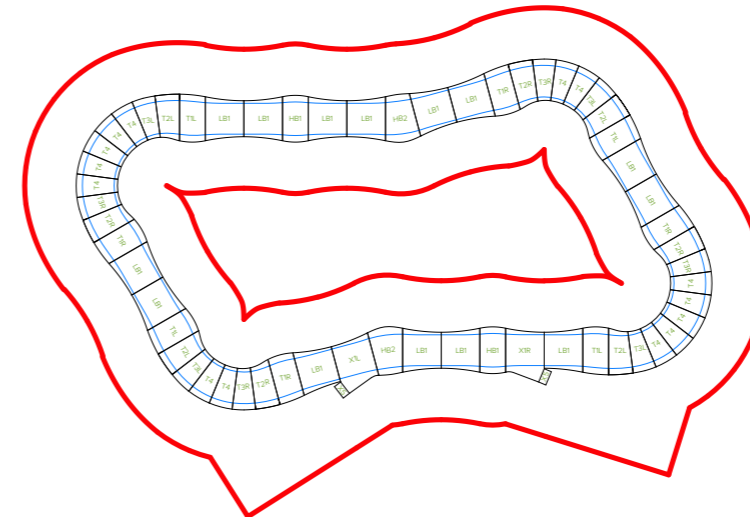

Short Sidewinder
RRP: €74'530
Length: 78.3m
Area: 117.5m2

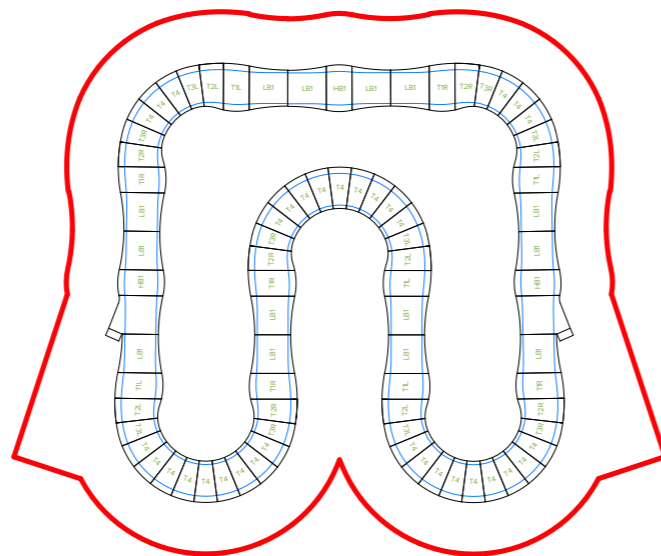

V4WC
RRP: €58'920
Length: 64.7m
Area: 94.2m2

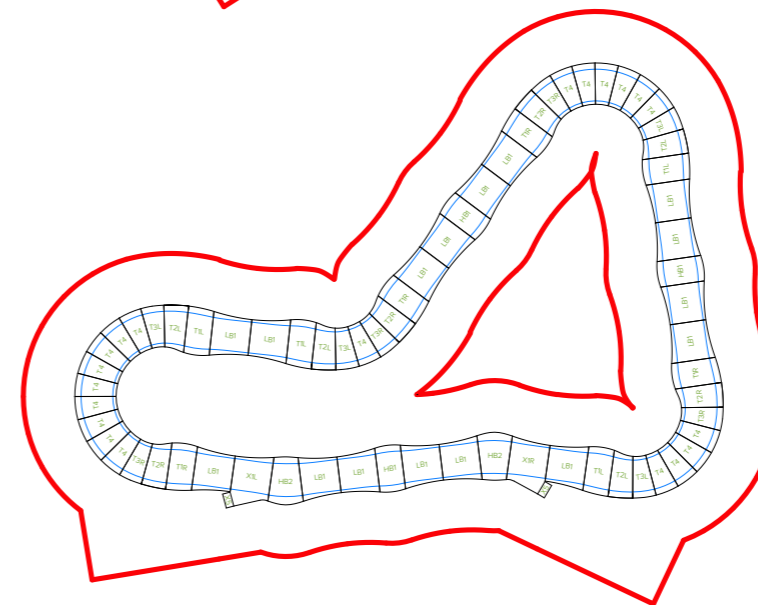



PARKITECT

Price List 2017 Plywood Composite

PARKITECT AG, Reutenenstrasse 22, 9042 Speicher, Switzerland
 info@parkitect.ch | www.parkitect.ch
 USt-IdNr. DE296421892 | MWSt - CHE-106.823.064

Track Layout	Part Count	Installation Area	Price
speed ring 	T1L+R 2+2 T2L+R 2+2 T3 18 B1 8	 <p>Rideable Length 36m</p>	£18'130 <small>stealth black</small> £19'040 <small>vulcan red</small> £19'580 <small>gulf blue</small>
tristar 	T1L+R 3+3 T2L+R 3+3 T3 15 B1 12	 <p>Rideable Length 46m</p>	£21'690 <small>stealth black</small> £22'770 <small>vulcan red</small> £23'420 <small>gulf blue</small>
quadragon 	T1L+R 4+4 T2L+R 4+4 T3 12 B1 12	 <p>Rideable Length 46m</p>	£22'690 <small>stealth black</small> £23'810 <small>vulcan red</small> £24'500 <small>gulf blue</small>
boomerang 	T1L+R 3+3 T2L+R 3+3 T3 23 B1 10 B3 1	 <p>Rideable Length 49m</p>	£24'800 <small>stealth black</small> £26'020 <small>vulcan red</small> £26'770 <small>gulf blue</small>
world cup 	T1L+R 4+4 T2L+R 4+4 T3 22 B1 16 B3 1 S1 2	 <p>Rideable Length 65m</p>	£31'190 <small>stealth black</small> £32'730 <small>vulcan red</small> £33'670 <small>gulf blue</small>

Track Layout	Part Count	Installation Area	Price
--------------	------------	-------------------	-------

advanced



T1L+R	6+6
T2L+R	6+6
T3	26
B1	18
S1	4

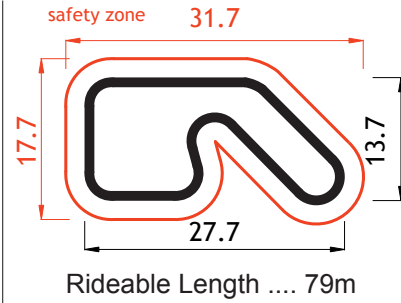

£38'670	stealth black
£40'600	vulcan red
£41'770	gulf blue

sidewinder



T1L+R	5+5
T2L+R	5+5
T3	33
B1	24
B3	2

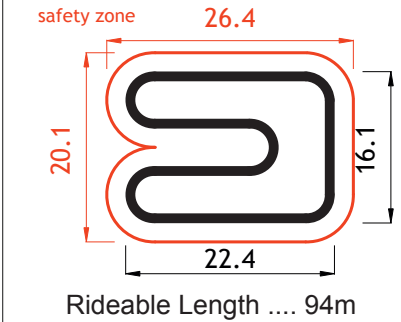

£43'780	stealth black
£45'960	vulcan red
£47'270	gulf blue

grand prix



T1L+R	6+6
T2L+R	6+6
T3	38
B1	26
B3	1
S1	3

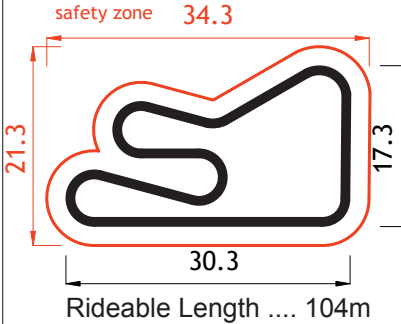

£49'980	stealth black
£52'480	vulcan red
£53'980	gulf blue

ranch



T1L+R	9+9
T2L+R	9+9
T3	60
B1	36
B3	1
S1	2

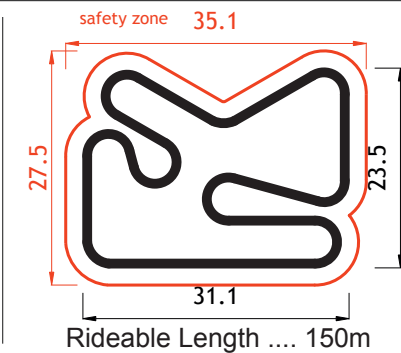

£73'730	stealth black
£77'420	vulcan red
£79'630	gulf blue



Colours	Name	RAL code
---------	------	----------





stealth black	RAL9005
vulcan red	RAL3020
gulf blue	RAL5012

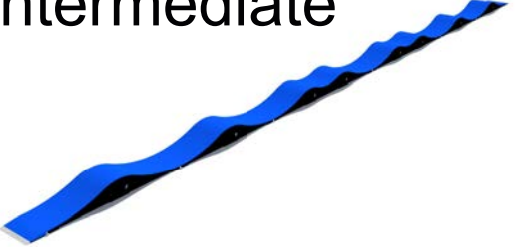
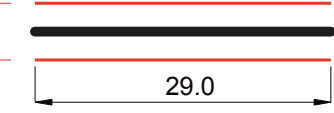
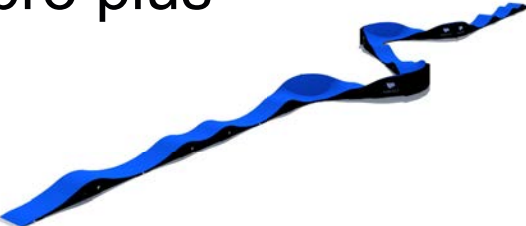
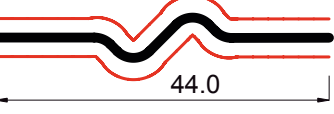

10 STANDARD MODULES =
UNLIMITED
 OPPORTUNITIES TO CREATE
 AWESOME FUN!

Rhythm Straights	Part Count	Installation Area	Price
beginners 	B01 6 DB1 1 X06 2	 rideable length 15m	£6,420 <small>stealth black</small> £6,745 <small>vulcan red</small> £6,935 <small>gulf blue</small>
intermediate 	B01 12 DB1 2 X06 2	 rideable length 29m	£9,990 <small>stealth black</small> £10,490 <small>vulcan red</small> £10,790 <small>gulf blue</small>
pro plus 	T1L+R 4+4 T2L+R 4+4 T03 6 B01 12 DB1 2 X06 2	 rideable length 50m	£22,265 <small>stealth black</small> £23,375 <small>vulcan red</small> £24,045 <small>gulf blue</small>

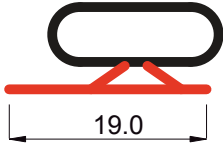
Options	Part Count	Installation Area	Price
entry/exit kit 	X1L+R 1+1 X5L+R 1+1	 * pricing if purchasing kit with new track	£4,060 <small>*£2,180 stealth black</small> £4,265 <small>*£2,270 vulcan red</small> £4,385 <small>*£2,350 gulf blue</small>
accelerator kit 	B01 6 G01 4 X1L+R 2+2 X06 2 X7L+R 1+1		£11,900 <small>stealth black</small> £12,495 <small>vulcan red</small> £12,855 <small>gulf blue</small>

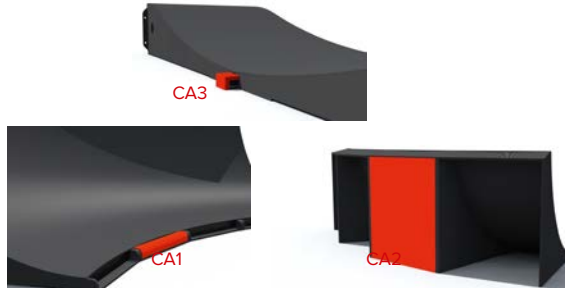
city armour kit	Track layout	CA1	CA2	CA3	Package
		speed ring £810 tristar £675 quadragon £540 boomerang £1,035 world cup £990 advanced £1,170 sidewinder £1,485 grand prix £1,710 ranch £2,700	£1,620 £1,350 £1,080 £2,070 £1,980 £2,340 £2,970 £3,420 £5,400	£216 £325 £325 £270 £435 £490 £650 £705 £975	£2,646 £2,349 £1,944 £3,375 £3,402 £3,996 £5,103 £5,832 £9,072

Also available tamper resistant hardware, contact us to discuss the options.

This price list cancels and replaces all previous price lists and package content lists for BIKEPARKITECT S.r.o. products. It is valid until further notice. Parkitect AG reserves the right to change prices to cope with inflation, material price fluctuations, and market conditions. Applicable taxes, shipping, installation and all other costs are NOT included.