

CLIENT:
 Melbourn Parish Council
 30 High Street, Melbourn
 SG8 6DZ

PROJECT: Stockbridge Meadows Boardwalk

DRAWING STAGE: Technical design

DRAWING STATUS: For consideration

1731

ltd

TITLE: Boardwalk overview (2)	
SCALE: As dimensions	
DRAWN BY: TU	DWG no: (30)005
DATE: 15-sept-2020	

Existing boardwalk
location

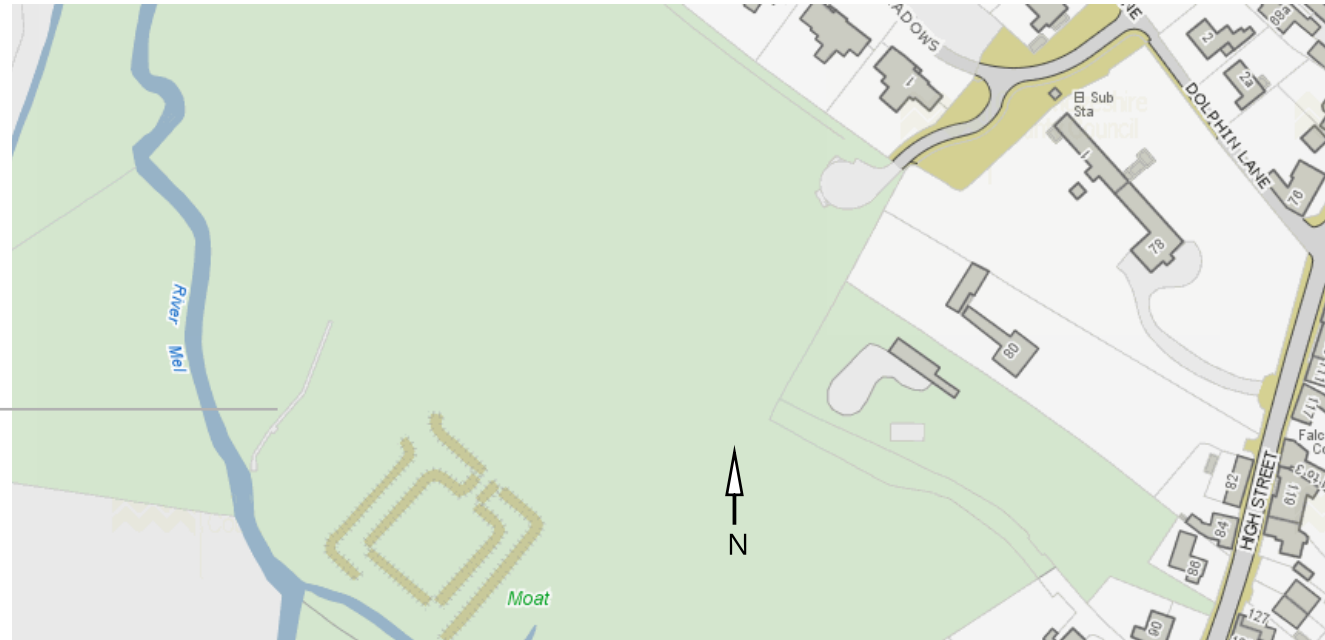

CLIENT: Melbourn Parish Council 30 High Street, Melbourn SG8 6DZ
--

PROJECT: Stockbridge Meadows Boardwalk
DRAWING STAGE: Technical design
DRAWING STATUS: For consideration

1731
ltd

TITLE: Boardwalk location	
SCALE: As dimensions	
DRAWN BY: TU	DWG no: (30)003
DATE: 15-sept-2020	

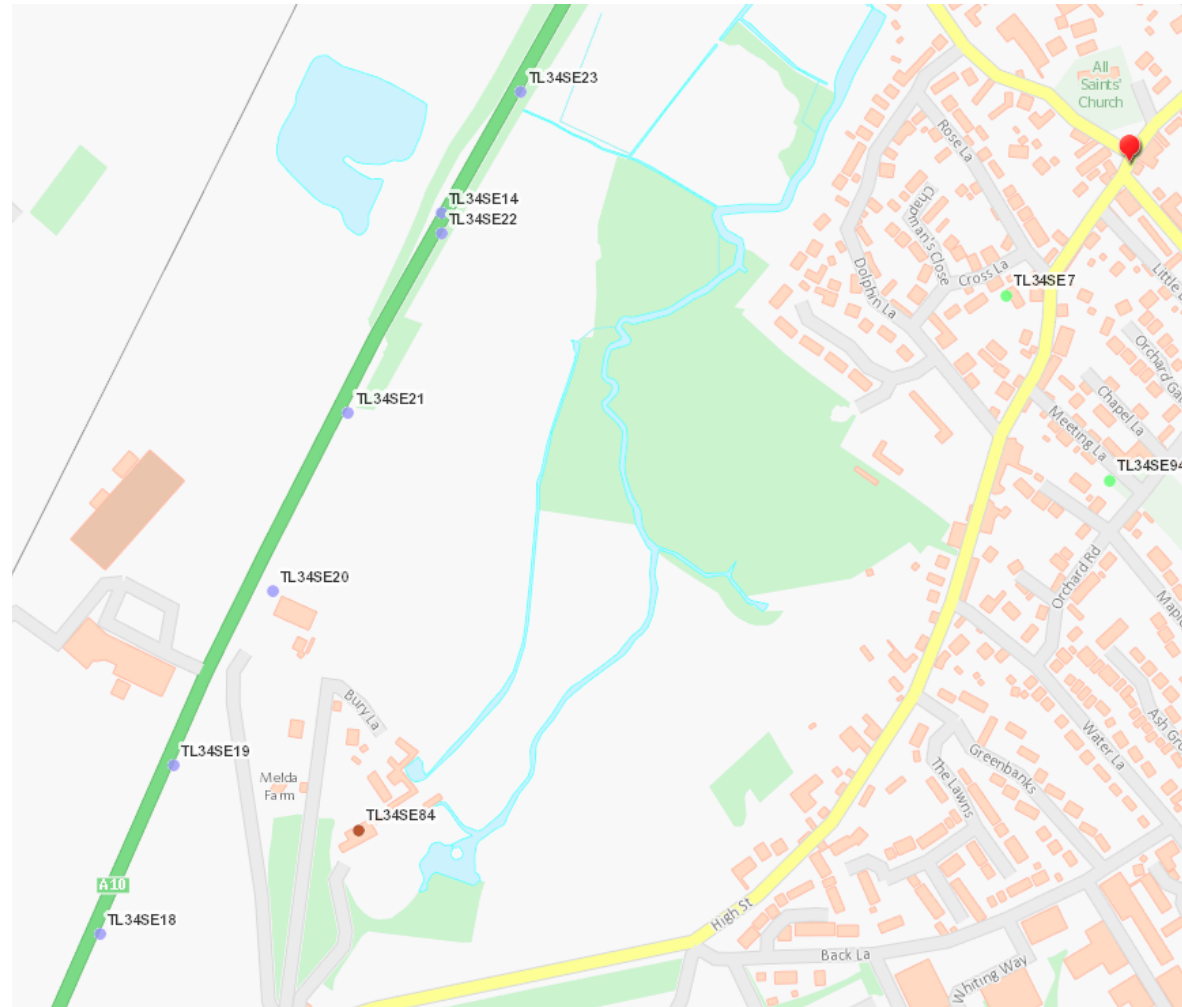

CLIENT: Melbourn Parish Council 30 High Street, Melbourn SG8 6DZ	PROJECT: Stockbridge Meadows Boardwalk
	DRAWING STAGE: Technical design
	DRAWING STATUS: For consideration

1731

ltd

TITLE: Boardwalk geological map - nearby borehole locations	
SCALE: As dimensions	
DRAWN BY: TU	DWG no: (30)004
DATE: 15-sept-2020	

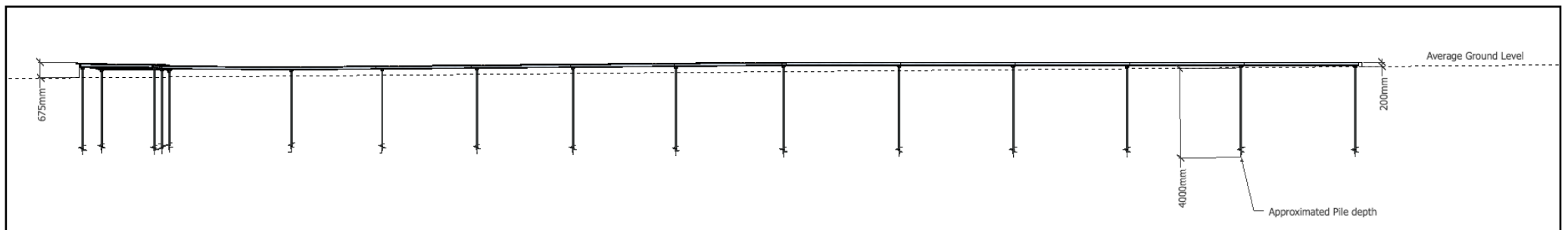
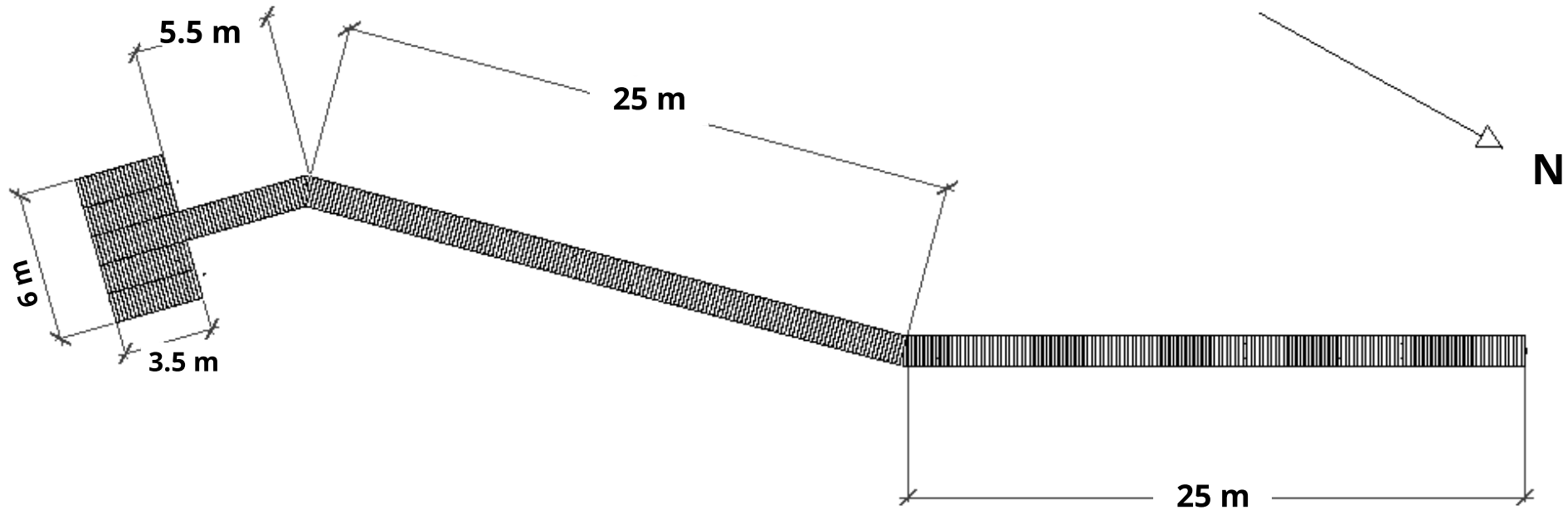

CLIENT:
Melbourn Parish Council
30 High Street, Melbourn
SG8 6DZ

PROJECT: Stockbridge Meadows Boardwalk
DRAWING STAGE: Technical design
DRAWING STATUS: For consideration

1731

ltd

TITLE: Boardwalk overview
SCALE: As dimensions
DRAWN BY: TU | DWG no: (30)001
DATE: 15-sept-2020

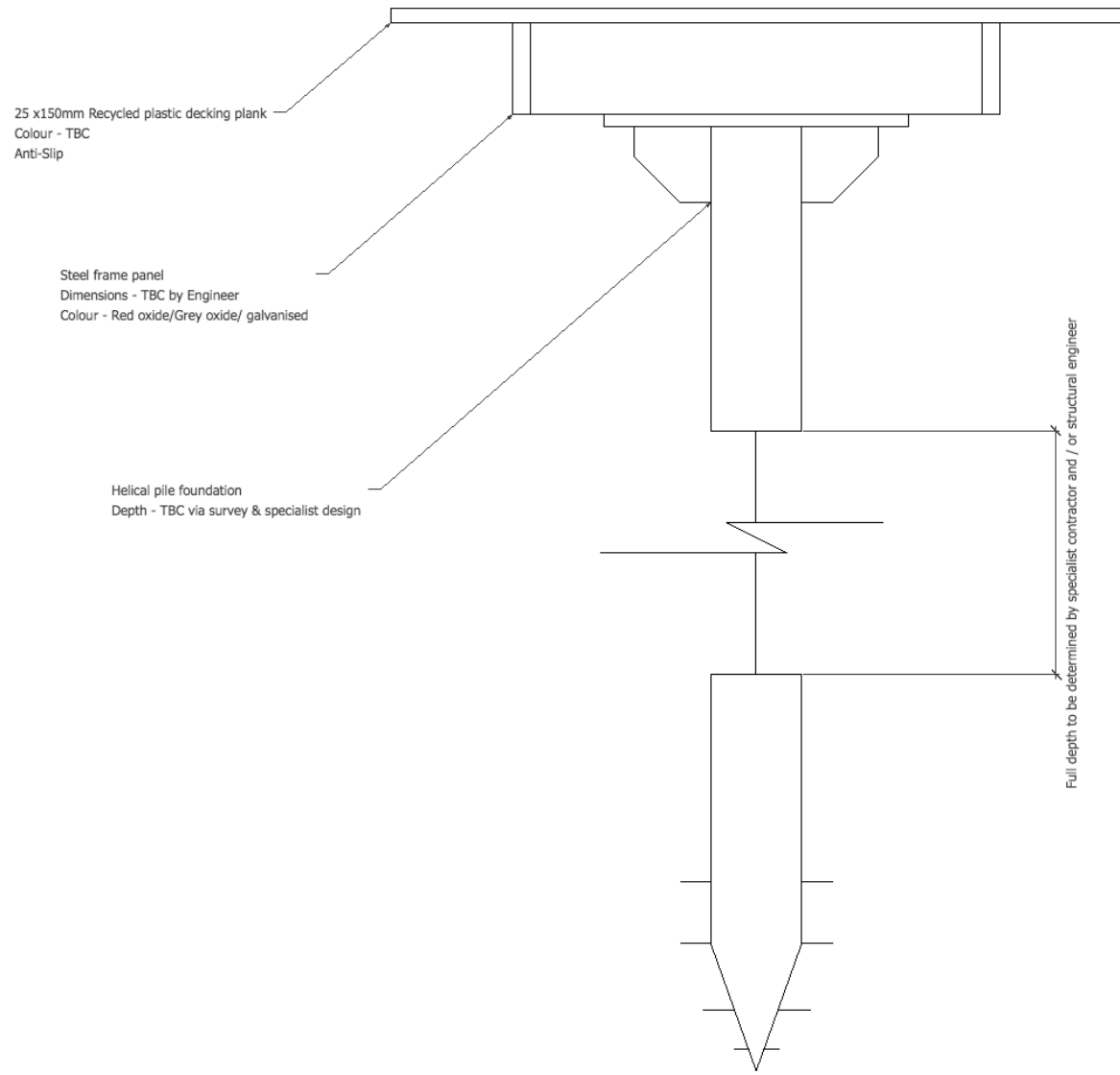

25 x150mm Recycled plastic decking plank
 Colour - TBC
 Anti-Slip

Steel frame panel
 Dimensions - TBC by Engineer
 Colour - Red oxide/Grey oxide/ galvanised

Helical pile foundation
 Depth - TBC via survey & specialist design

Full depth to be determined by specialist contractor and / or structural engineer

CLIENT: Melbourn Parish Council 30 High Street, Melbourn SG8 6DZ	PROJECT: Stockbridge Meadows Boardwalk
	DRAWING STAGE: Technical design
	DRAWING STATUS: For consideration
	(Empty cell)

1731

ltd

TITLE: Boardwalk section through pile	
SCALE: As dimensions	
DRAWN BY: TU	DWG no: (30)002
DATE: 15-sept-2020	

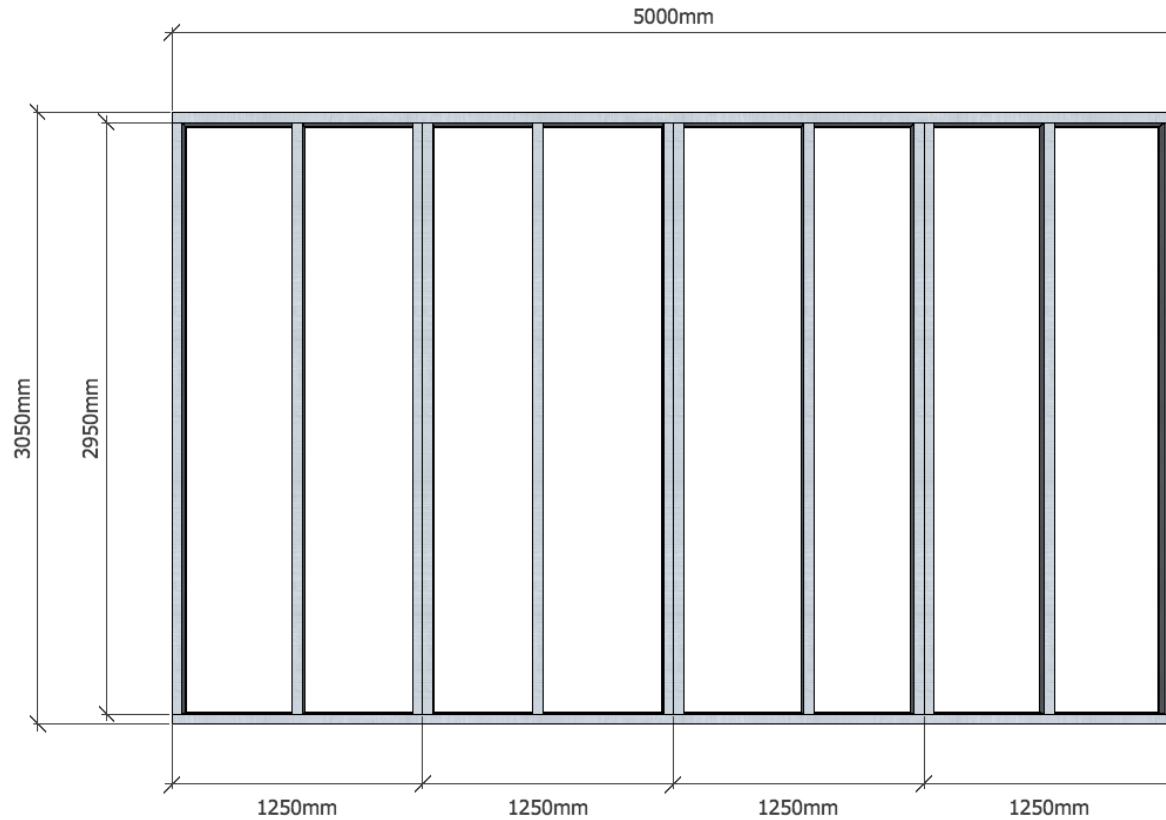
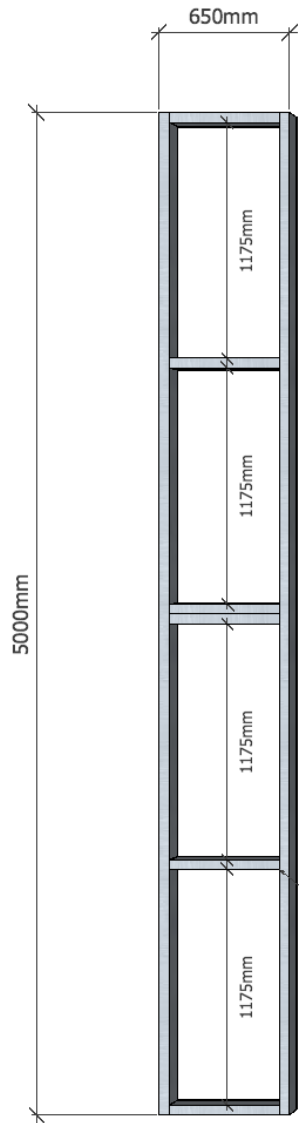

Frames - 5000*650mm
 QTY = 13
 Frames - 3050*1250mm
 QTY = 4
 Connection detail to pile
 TBC by S/E

All constructed of 50*100*4mm
 Box section - S/E to confirm

All constructed of 50*100*4mm
 Box section - S/E to confirm

CLIENT:
 Melbourn Parish Council
 30 High Street, Melbourn
 SG8 6DZ

PROJECT: Stockbridge Meadows Boardwalk
 DRAWING STAGE: Technical design
 DRAWING STATUS: For consideration

1731
 ltd

TITLE: Boardwalk deck frame
 SCALE: As dimensions
 DRAWN BY: TU | DWG no: (30)006
 DATE: 15-sept-2020

